

# U-Pin Polyamide Motif for Recognition of the DNA Minor Groove

Alexander Heckel and Peter B. Dervan\*<sup>[a]</sup>

**Abstract:** DNA-binding hairpin pyrrole–imidazole polyamides with  $\gamma$ -aminobutyric acid as a turn-forming residue tolerate A•T or T•A base pairs under the turn. U-pins—polyamides with a different turn—have been synthesized and their DNA binding properties were studied. The two turn-forming residues are connected via the ring nitrogens using variable length aliphatic linkers ( $(\text{CH}_2)_n$ ,  $n = 3–6$ ). Through optimization of the linker length and the substituents at the 2-position of the pyrrole residue on the U-turn, polyamides with G•C/C•G tolerant turns could be found, which bind to DNA in a predictable manner.

**Keywords:** amino acids • DNA recognition • pyrrole–imidazole polyamides • U-pins

## Introduction

Polyamides made from *N*-methylpyrrole (Py), *N*-methylimidazole (Im) and *N*-methyl-3-hydroxypyrrole (Hp) amino acids bind with high affinities and sequence specificities to the minor groove of double stranded DNA. This opens the door to an array of potential applications, for example regulating gene expression and chromosomal staining.<sup>[1, 2]</sup> The progression from the natural products netropsin and distamycin to the current picture of DNA recognition with polyamides has been summarized in a recent review article.<sup>[1a]</sup> This journey has included systematic variations of atoms, substituents, residues and entire motifs and the DNA-binding characteristics of each variant have been measured by quantitative footprinting titrations. Hairpin polyamides consist of two strands of aromatic amino acids which are positioned antiparallel side-by-side in the minor groove of DNA. A pairing rule paradigm has been developed, wherein a Py/Im pair targets a C•G base pair, while an Im/Py pair targets a G•C base pair. Likewise, a Py/Hp combination distinguishes A•T from T•A. A Py/Py pair is degenerate and binds to both A•T and T•A but not to G•C or C•G. Figure 1<sup>[3]</sup> shows a mnemonic to illustrate how polyamides read the recognition pattern present in the minor groove. This model presents our view of polyamides as modular DNA-recognition tools, constructed using simple rules and a small set of readily available monomer units (the residues). Polyamides target a considerable number of DNA sequences with

high affinity and selectivity; however, there are limitations. Covalently linking the antiparallel polyamide strands with a  $\gamma$ -aminobutyric acid residue (GABA) in the hairpin motif affords higher affinity binders. This also ensures a heterodimeric<sup>[4]</sup> binding mode with the DNA and locks the register of the two strands with respect to each other, increasing the specificity.<sup>[5]</sup> However, the hairpin motif has a sequence requirement under the GABA turn residue, tolerating only A•T/T•A base pairs for steric reasons.<sup>[6]</sup> In a recent investigation the influence of different tail residues on G/C tolerance was studied.<sup>[7]</sup> Here, the ability of a new turn motif to provide a similar G/C tolerance at the other end of the recognition site are explored.

The intolerance of a GABA turn toward G•C/C•G base pairs is due to the conflict with the steric bulk presented by the exocyclic amino group of a guanine residue. This NH<sub>2</sub> group points outwards from the bottom of the minor groove “on” which the alkyl chain of the GABA turn lies. An alternative way to connect two polyamide strands is the “H-pin” motif<sup>[8, 9]</sup> in which two *N*-methyl groups of central residues are connected with an alkyl chain leading to polyamide molecules that resemble the letter “H” (Figure 2). While these molecules have the potential to target G•C/C•G tracts they are significantly different in their architecture from hairpin polyamides because they have a branched structure. As a result they are more difficult to synthesize especially on solid phase.<sup>[9]</sup> Moving the bridge away from the internal residues, toward the edge of the molecule creates a linear oligomer resembling the letter “U” (Figures 2 and 3).

We refer to this new class of polyamides as “U-pins” and to the turn as a “U-turn”. While this only seems to be a minor change, there were some caveats: To tolerate adjacent G/C base pairs, it was possible that the substituent R (Figure 3) on the U-pin would have to be hydrogen, to avoid a steric clash. Compared with the analogous hairpin polyamide **2**, such a

[a] Prof. P. B. Dervan, Dr. A. Heckel  
California Institute of Technology  
Division of Chemistry and Chemical Engineering  
The Beckman Institute  
Pasadena, CA 91125 (USA)  
Fax: (+1) 626-683-8754  
E-mail: dervan@caltech.edu

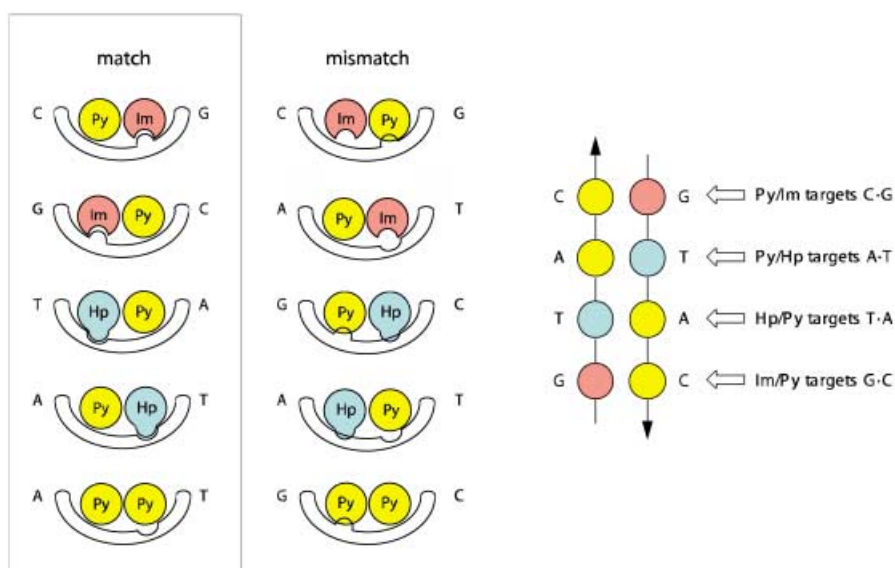

Figure 1. Dip-and-bump-mnemonic for polyamides reading the recognition pattern of the DNA minor groove. The pairing rules are represented as shape complementarities. Pyrrole residues are drawn in yellow, imidazole residues in red and hydroxypyrrole residues in blue. The bottom of the minor groove (shown as a crescent) presents its recognition pattern as a series of dips and bumps—dips for hydrogen-bond acceptors and bumps for hydrogen bond donors. A Py residue can be paired with itself (this combination tolerates but does not discriminate between A·T and T·A base pairs) or with an Im or an Hp residue. The former is drawn as a red ball with a dip (a hydrogen bond acceptor position) matching the bump (the NH<sub>2</sub> group) of a guanine base, the latter as a blue ball with a bump symbolizing the steric bulk and hydrogen bond donor capability of the hydroxy group. For polyamides with good binding affinities the following two rules must be obeyed: All bumps have to be matched by a dip and vice versa. As only exception, a Py/Py pair with its neutral surface can match the dip of an A·T base pair.<sup>[3]</sup>

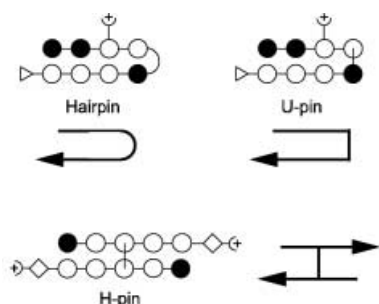

Figure 2. Three motifs for DNA-binding polyamides: Hairpin, U-pin and H-pin. As opposed to the two former, the latter has a branched architecture with a concomitant additional level of complication in the synthesis. In this black-and-white pictogram representation imidazole residues are drawn as black circles and pyrrole residues as open circles. A methyl amide tail is drawn as a triangle, a  $\beta$ -alanine residue as a diamond and an aminopropyl group as a crescent with a “+” sign. For structural formulae of these polyamides see Figure 3 and ref. [9]. The arrows indicate the N→C direction in the polyamide.

U-pin would have two fewer hydrogen bonds, and potentially lower affinity. Furthermore, U-pins could theoretically bind to DNA in modes other than the predicted “normal” one (Figure 4). U-pins could bind in reverse fashion, as is observed for certain hairpin polyamides.<sup>[10]</sup>

Additionally, U-pins could extend and bind in a “Z binding mode” or, if the bridge were long enough, in a fully linear binding mode. To address these questions, the U-pins **1a–f** which have different linker lengths and substituents were synthesized.

## Results and Discussion

To prepare U-pins using established solid-phase synthesis methods,<sup>[11]</sup> it was necessary to synthesize U-turn dimers (Scheme 1). Starting from the commercially available substituted pyrrole **3** compound **6** was obtained after nitration (→**4**), esterification (→**5**), reduction and Boc protection. Then imidazole was alkylated with acetyl-protected bromo alcohols of different chain lengths to obtain compounds **7a–c**. After trichloroacetylation the resulting trichloro ketones **8a–c** were converted to the O-deprotected alcohols **9a–c**. To obtain the dimer the alcohols were converted to the respective iodides using I<sub>2</sub>, PPh<sub>3</sub> and imidazole. After aqueous workup the crude mixture of the iodide and OPPh<sub>3</sub> was directly used for the alkylation of compound **6** to provide the compounds **10a–c**. This step was followed by deprotection of the carboxylic acid with TBAF and formation of methyl amides **11a–c**.

Finally, the building blocks **12a–c** were obtained after saponification of the ethyl ester. Because compounds **12a–c** readily decarboxylate upon acidification they were used as their sodium salts.

The six-carbon bridged dimers **12d**, **16** and **20** required a slightly different route (Scheme 2). Since the requisite acetyl-protected bromo alcohol is not commercially available, 1,6-hexanediol as used as the starting material. After monoacetylation<sup>[12]</sup> (→**13**) the protected diol was treated with I<sub>2</sub>, PPh<sub>3</sub> and imidazole. The crude iodide obtained after aqueous workup was used directly for the alkylation of imidazole (→**7d**). Trichloroacetylation (→**8d**) and esterification afforded compound **9d**, which was converted to the iodide and treated with the nitro-substituted pyrrole **5** to obtain compound **14**. Nitropyrrole **5** was found to give better alkylation yields than Boc-aminopyrrole **6**. Reduction and Boc protection of compound **14** provided compound **10d**. Deprotection and amide bond formation using MeNH<sub>2</sub> or NH<sub>3</sub> afforded compounds **11d** and **15**, respectively. After saponification, the carboxylic acid sodium salts **12d** and **16** were obtained and again used without acidification to avoid decarboxylation. Preparing the minimally substituted component **18** using the crude iodide **17** and 3-nitropyrrole<sup>[13]</sup> proved to be impractical, due to separation difficulties—the use of purified iodide **17**,<sup>[14]</sup> however, proceeded smoothly. After reduction and Boc protection (→**19**), saponification afforded the sodium salt **20**. The remaining building blocks for the solid-phase synthesis were either commercially available or obtained accord-

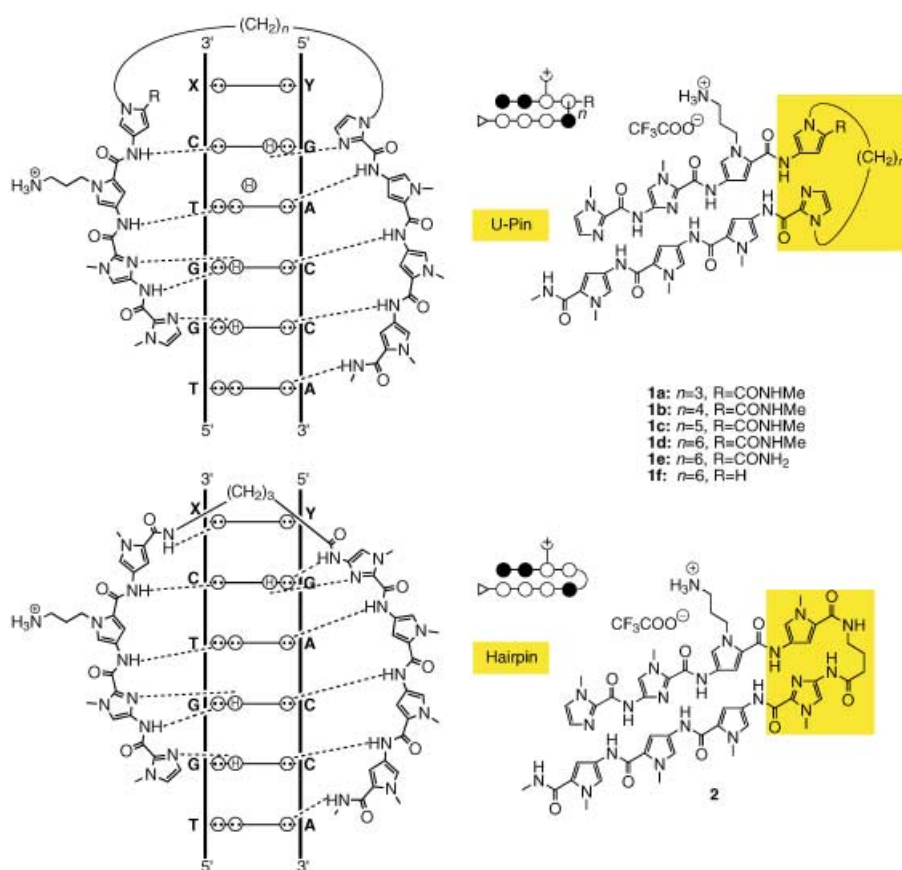

Figure 3. A comparison between U-pins and hairpins. Right: The U-pins **1a–f** and the reference hairpin polyamide **2** synthesized for this study. Left: Hydrogen bonding pattern of hairpins and—extrapolating—the putative hydrogen bonding pattern of U-pins. In this “exploded view” the minor groove of DNA is drawn as ladder. The steps of the ladder are the planes of the base pairs which present their respective recognition elements: electron pairs (two dots in a circle) and H-bond donors (H in a circle).

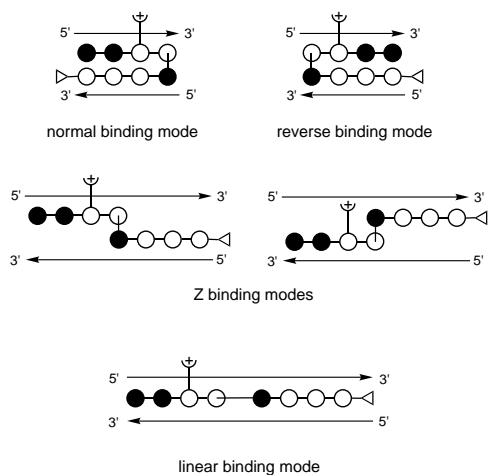

Figure 4. Representations of theoretically possible binding modes of U-pins. In the “normal” binding mode the N→C direction of the polyamide is parallel to the 5'→3' direction of the DNA, whereas in the reverse binding mode it is antiparallel. These two binding modes have been observed for hairpin polyamides with the latter occurring in some exceptional cases only.<sup>[10]</sup> Depending on the length of the bridge in the U-turn, binding in a previously unknown “Z binding mode” or—in case of longer bridges—in a linear (or 1:1) binding mode could also be theoretically possible. Since the upper and lower strands of the DNA are arbitrarily defined, the polyamide could of course also fit into the minor groove after a 180° rotation around an axis perpendicular to the helix axis—given an appropriate recognition pattern in the minor groove.

ing to literature procedures.<sup>[2, 15, 16]</sup> Following established solid phase synthesis protocols<sup>[7, 11]</sup> and using oxime resin, the U-pins **1a–f** and the hairpin **2** were synthesized and purified by RP-HPLC (Scheme 3).

At first the question of the optimal linker length was addressed. Therefore, DNase I footprinting titration experiments were performed with the U-pins **1a–d** and the hairpin polyamide **2** as reference compound on a restriction fragment of the plasmid pDEH9 (Figure 5). This 250 base-pair sequence has several potential binding sites of interest. Ideally, the U-pins **1a–f** should read a sequence 5'-GGWC-3' (W = A, T). The site labeled “A” is the only match site on this restriction fragment; sites “B” and “C” are both designed single base pair mismatch sites. Site “D” contains overlapping regions to which the U-pins could bind in all of the unwanted binding modes (see Figure 4). The lower left corner of Figure 5 shows the result of a footprinting titration with the

reference hairpin **2**. The affinities to the respective binding sites are summarized in Table 1. Reference hairpin **2** binds with high affinity and specificity to the match site (site “A”).

Surprisingly, the U-pins showed a very similar behavior. In all cases the footprint at the match binding site is the dominant feature. U-pins **1a, b** and **d** bind the DNA with affinities nearly equal to that of reference compound **2**—a surprising result since these U-pins have one hydrogen bond less than the reference compound. Only U-pin **1c** with a five-carbon linker has a significantly lower affinity in this DNA context. A recent study on H-pins<sup>[9]</sup> showed a similar behavior for the linker lengths: polyamides with a 4- or 6-carbon bridge displayed the highest affinities, while polyamides with a five-carbon bridge displayed lower affinities.

Significantly, the U-pins bind DNA in the “normal” mode essentially exclusively. For example, no footprint is observed at site D, where the U-pins could theoretically bind in several possible undesired binding modes. Furthermore, the U-pins display specificities for the match over the single base pair mismatch site that are comparable to the ones of hairpin polyamide **2**. Non-specific binding was only observed with U-pin **1d** at 5 nM or higher concentrations. Nonetheless, U-pin **1d** displays significant DNA binding at concentrations below 5 nM and it had the best overall affinity in the series.

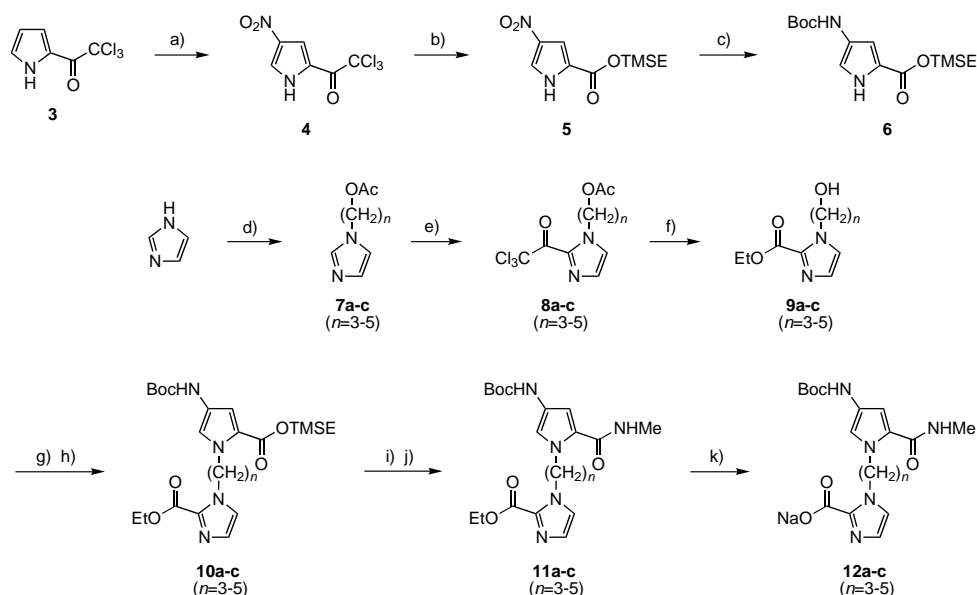

Scheme 1. Synthesis of the U-turn building blocks **12a–c**. a)  $\text{HNO}_3$ ,  $\text{Ac}_2\text{O}$ ; b) TMSEOH, NaH; c) 1.  $\text{H}_2$ , Pd/C, 2. Boc<sub>2</sub>O, NaHCO<sub>3</sub>; d)  $\text{Br}(\text{CH}_2)_n\text{OAc}$ , NaH; e)  $\text{CCl}_3\text{COCl}$ ; f) NaOEt; g) **5**,  $\text{K}_2\text{CO}_3$ ; h) **6**,  $\text{K}_2\text{CO}_3$ ; i) TBAF; j) 1. DCC, HOBT, 2. MeNH<sub>2</sub>, DIEA; k) NaOH.

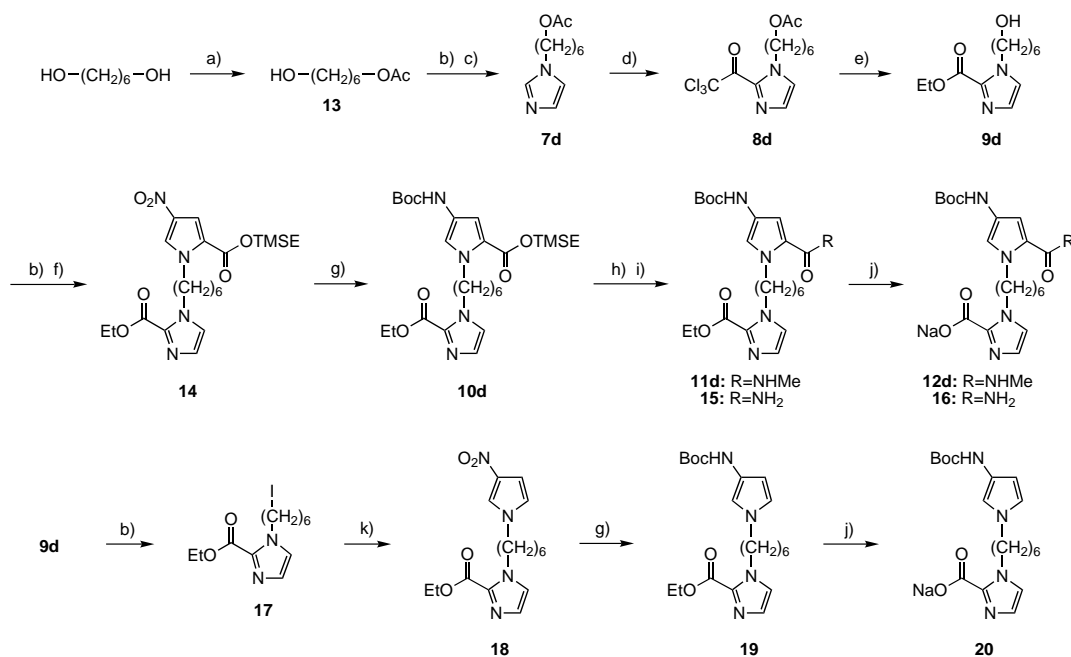

Scheme 2. Synthesis of the U-turn building blocks **12d**, **16** and **20**. a)  $\text{Ce}(\text{SO}_4)_2/\text{silica gel}$ , EtOAc; b)  $\text{I}_2$ , PPh<sub>3</sub>, Im; c) Im, NaH; d)  $\text{Cl}_3\text{CCOCl}$ ; e) NaOEt; f) **5**,  $\text{K}_2\text{CO}_3$ ; g)  $\text{H}_2$ , Pd/C, Boc<sub>2</sub>O; h) TBAF; i) 1. DCC, HOBT, 2. MeNH<sub>2</sub> or NH<sub>3</sub>, DIEA; j) NaOH; k) 3-nitropyrrole,<sup>[13]</sup>  $\text{K}_2\text{CO}_3$ .

The tolerance for G/C adjacent to the U-turn element was examined using plasmid pAH2 which incorporates designed sites 5'-TGGTCX-3' that differ only in the base pair adjacent to the core binding site (Figure 6). The X = T site appears twice because it is also part of the plasmid pUC19,<sup>[17]</sup> from which pAH2 was cloned.

Figure 7 shows the results of the footprinting experiments with reference hairpin polyamide **2** and U-pins **1d–f**. The binding affinities to the respective sites are summarized in Table 2 and represented graphically in Figure 8.

As expected, the GABA residue of the hairpin polyamide **2** tolerates an A · T or T · A base pair at the turn position, but the

binding affinity drops by one order of magnitude for X = C and no binding was observed for X = G in the concentration ranges used. This confirms the trend which had been previously found for hairpin polyamides.<sup>[6]</sup> U-pins **1b** and **d** (with methyl amide substituents) encounter a lower energetic penalty for binding the sites with X = C or G, but these compounds also bind with slightly lower affinities than hairpin polyamide **2**. As pointed out earlier, a U-pin, such as **1b** or **d**, has one hydrogen bond less than a comparable hairpin polyamide such as **2**. Interestingly, in this DNA context U-pin **1b** showed approximately the same affinity as U-pin **1d**, while U-pin **1d** showed a higher affinity on the restriction fragment

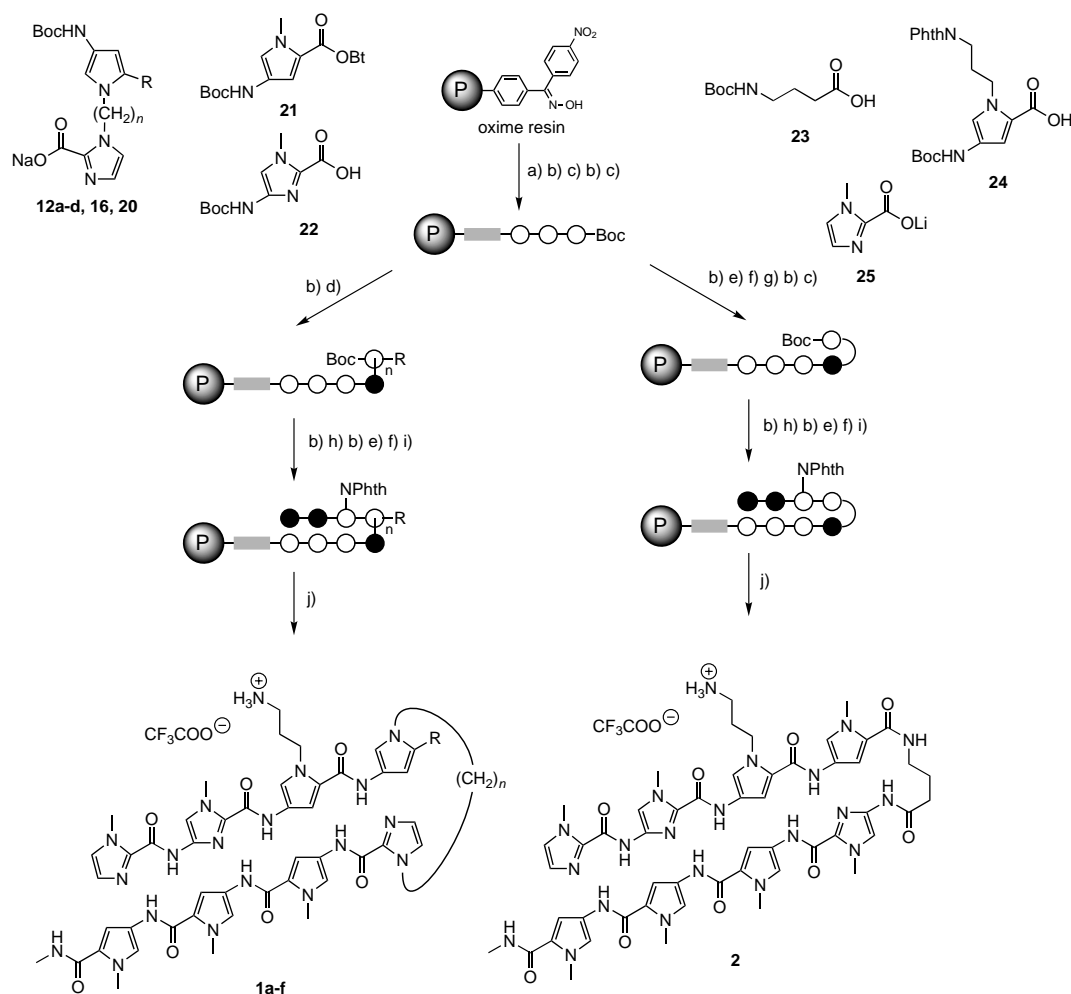

Scheme 3. Solid-phase synthesis of the U-pin polyamides **1a–f** and hairpin polyamide **2** on oxime resin. In the pictogram representation the linker of the oxime resin is drawn as a gray bar and the pyrrole and imidazole residues as circles according to the rules explained in Figure 2. a) 3 equiv **21**, 6 equiv DIEA, DMF, 14 h, RT, wash with DMF, CH<sub>2</sub>Cl<sub>2</sub>; b) 25% TFA in CH<sub>2</sub>Cl<sub>2</sub>, 2 × 30 s, 2 × 10 min, wash with CH<sub>2</sub>Cl<sub>2</sub>, DMF, DMF/DIEA, DMF; c) 3 equiv **21**, 6 equiv DIEA, DMF, 2 h, RT, wash with DMF, CH<sub>2</sub>Cl<sub>2</sub>; d) 3 equiv **12a–d**, **16** or **20** (activated with 2.7 equiv HBTU, 6 equiv DIEA, DMF, 15 min, RT), 2 h, RT, wash with DMF, CH<sub>2</sub>Cl<sub>2</sub>; e) 3 equiv **22** (activated with 2.7 equiv HBTU, 6 equiv DIEA, DMF, 15 min, RT), 2 h, RT, wash with DMF, CH<sub>2</sub>Cl<sub>2</sub>; f) 50% TFA in CH<sub>2</sub>Cl<sub>2</sub>, 2 × 30 s, 2 × 10 min, wash with CH<sub>2</sub>Cl<sub>2</sub>, DMF, DMF/DIEA, DMF; g) 9 equiv **23** (activated with 7 equiv HBTU, 6 equiv DIEA, DMF, 15 min, RT), 14 h, 37 °C, wash with DMF, CH<sub>2</sub>Cl<sub>2</sub>; h) 4 equiv **24** (activated with 3.8 equiv HOBt, 3.8 equiv DCC, DMF, 2.5 h, RT), 6 equiv DIEA, 2 h, RT, wash with DMF, CH<sub>2</sub>Cl<sub>2</sub>; i) 7 equiv **25** (activated with 4 equiv HBTU, 6 equiv DIEA, DMF, 20 min, RT), 14 h, 37 °C, wash with DMF, CH<sub>2</sub>Cl<sub>2</sub>, CH<sub>2</sub>Cl<sub>2</sub>/MeOH, CH<sub>2</sub>Cl<sub>2</sub>; j) saturated solution of MeNH<sub>2</sub> in MeOH, 1 h, 37 °C, wash with MeOH, CH<sub>2</sub>Cl<sub>2</sub>, MeOH.

Table 1. Equilibrium association constants [ $M^{-1}$ ] obtained in DNase I footprinting experiments with the *EcoRI/PvuII* restriction fragment of the plasmid pDEH9 and the polyamides **1a–d** and **2** (see also Figure 5). All experiments were performed at least three times. Given are the average values and the standard deviations (in parentheses).

Polyamide	5'-TGGTCA-3' (site "A")	5'-TGGCCA-3' (site "B")	5'-TGGGCA-3' (site "C")
<b>1a</b> ( $n = 3$ , R = CONHMe)	$7.7 \times 10^9$ (1.1)	$\approx 1 \times 10^8$	$\approx 2 \times 10^8$
<b>1b</b> ( $n = 4$ , R = CONHMe)	$8.0 \times 10^9$ (1.2)	$< 10^8$	$< 10^8$
<b>1c</b> ( $n = 5$ , R = CONHMe)	$2.6 \times 10^9$ (0.5)	$< 10^8$	$< 10^8$
<b>1d</b> ( $n = 6$ , R = CONHMe)	$1.7 \times 10^{10}$ (0.3)	$(5 \times 10^8)^{[a]}$	$(5 \times 10^8)^{[a]}$
<b>2</b> (hairpin)	$1.3 \times 10^{10}$ (0.2)	$\approx 4 \times 10^8$	$\approx 7 \times 10^8$

[a] At this threshold polyamide **1d** binds nonspecifically to the DNA fragment.

pairs A · T, T · A and C · G with equal affinities. However, a G · C base pair (where the exocyclic NH<sub>2</sub> group of the G base is closer to the substituent on the U-turn as in a C · G pair) still causes a drop in affinity. Only U-pin **1f** with the unsubstituted turn tolerates all base pairs equally. Its affinity is again lower which was to be expected since this U-pin has one hydrogen bond less than U-pins **1b**, **d** and **e** and two hydrogen bonds less than the hairpin polyamide **2**. As a reference, six-ring hairpin polyamides which have the same number of hydrogen bonds generally bind with an equilibrium association constant of  $K_a \approx 10^8 M^{-1}$ .<sup>[18]</sup>

## Summary and Outlook

In summary, we have presented a new motif for minor groove-binding pyrrole–imidazole polyamides. The U-pins were designed to have a G/C-tolerant turn. While U-pins might

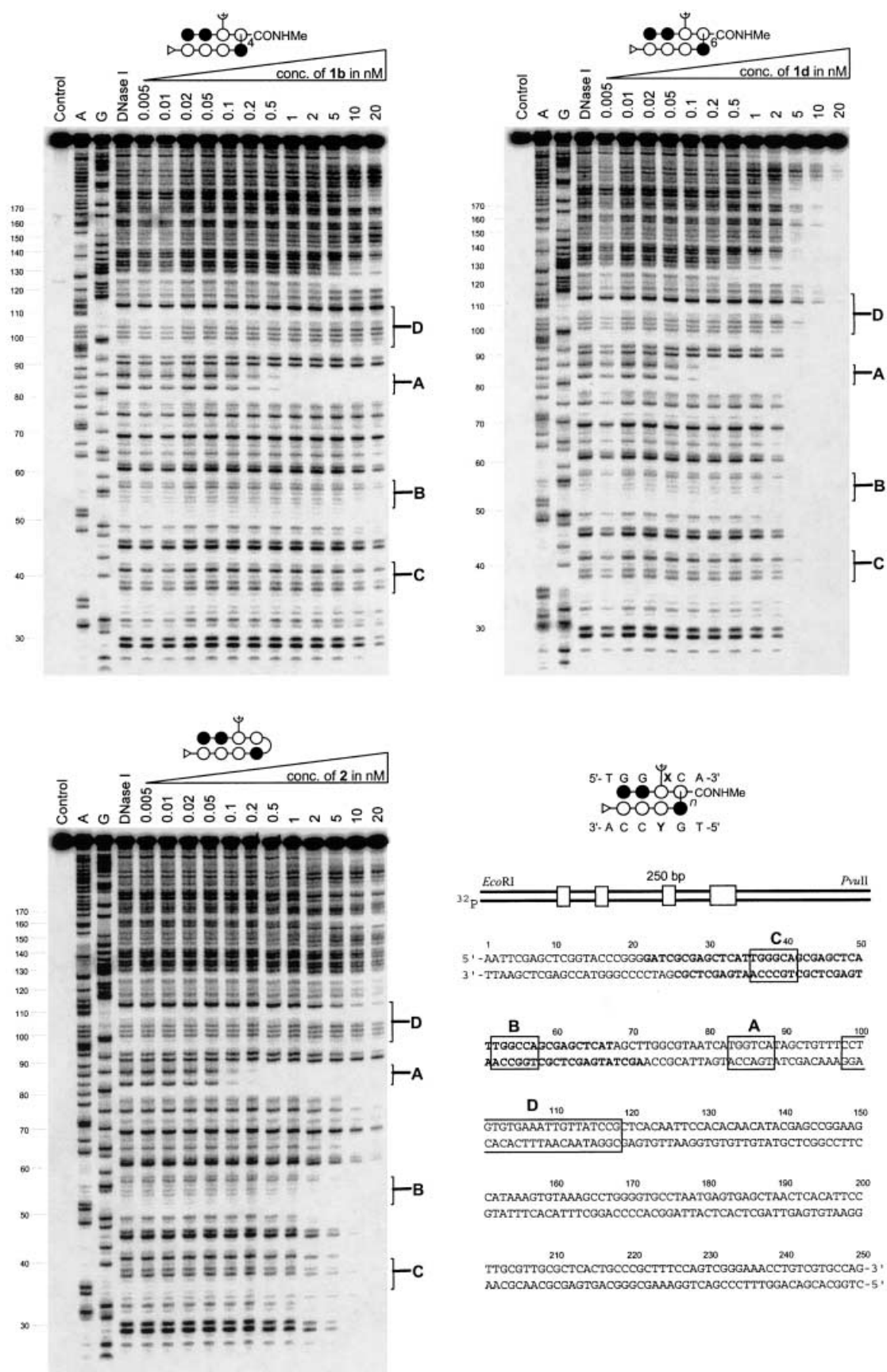

Figure 5. Results of DNase I footprinting experiments with the *EcoRI/PvuII* restriction fragment of the plasmid pDEH9 and the polyamides **1b**, **d** and **2**. In the lower right corner the sequence of the restriction fragment is shown (insert used for cloning in bold-face) and the four binding sites of interest are labeled A, B, C and D (for a discussion see text). The only match site for such a U-pin is site A. The numbers indicate the position on the DNA fragment.

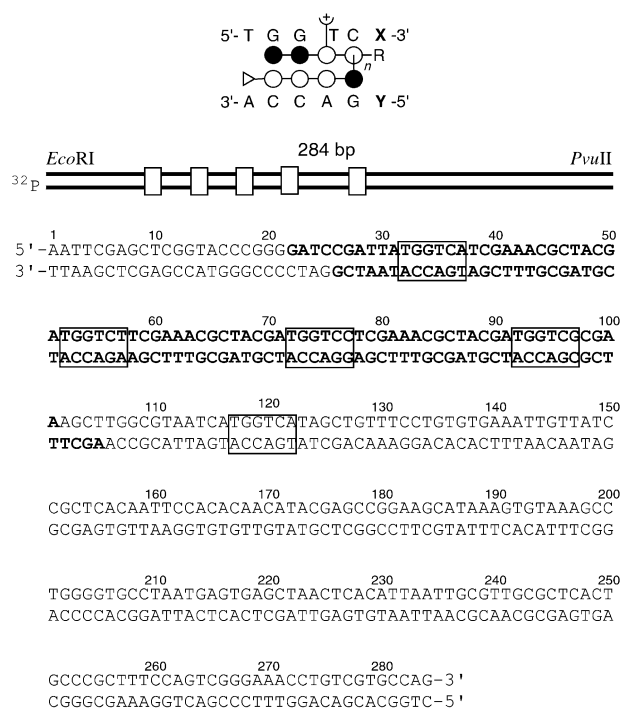

Figure 6. Sequence of the *EcoRI*/*PvuII* restriction fragment of the plasmid pAH2. The binding sites of interest are marked with boxes. The insert used in the cloning process is shown in bold face.

theoretically bind to DNA in different binding modes (Figure 4), only binding in the so-called “normal” mode was observed and the U-pins showed good selectivity for binding to match over mismatch sites. U-pins tolerate several different linker lengths with the exception of five linking carbon atoms. Probing the influence of the substitution of the turn on G/C tolerance, it was found that U-pin **1e** is best for tolerating a C·G base pair. Finally, in order to target a DNA sequence in a larger context which has a G·C base pair in the turn region it was necessary to remove all substituents on the U-turn, as evident from the binding behavior of U-pin **1f**. The U-pin motif extends the repertoire of DNA sites that can be targeted by polyamides.

## Experimental Section

Compounds **21**,<sup>[11a]</sup> **22**,<sup>[11a]</sup> **24**,<sup>[2,9]</sup> and **25**<sup>[16]</sup> were obtained according to literature procedures. All other chemicals used were purchased from Aldrich. All reactions were performed under an Ar atmosphere and using dry solvents. NMR spectra were recorded on a 300 MHz Varian Mercury

spectrometer. The spectra were referenced as indicated, using reported chemical shifts for the respective signals.<sup>[19]</sup> Peaks were assigned by 2D NMR spectroscopy and by comparison. UV/Vis spectra were recorded on a Hewlett-Packard 8452A diode array spectrometer. High resolution mass spectrometry was performed at the Mass Spectrometry Facility of the University of California, Los Angeles (UCLA). All other mass spectra were recorded at the mass spectrometry facility of the Division of Chemistry and Chemical Engineering at Caltech. Analytical HPLC: Beckman System Gold, 125 Solvent Module, 168 Detector, 508 Autosampler, software: Gold Nouveau V1.7, unless otherwise noted the following conditions were used: column: Varian Microsorb MV 300-8 C18, flow: 1 mL min<sup>-1</sup>, solvents: A = 0.1% TFA in H<sub>2</sub>O, B = MeCN, gradient: 0 → 60% B linear in 30 min. Preparative HPLC: Beckman System Gold, 127P Solvent Module, 166P Detector, columns: 1) Waters PrepLC 25 mm module, 2) Hamilton PRP-1, unless otherwise noted the following conditions were used: solvents: A = 0.1% TFA in H<sub>2</sub>O, B = MeCN, gradient: 0% B (0 min), 0% B (5 min), 20% B (30 min), 25% B (50 min), 35% B (60 min), 45% B (70 min), linear. Unless otherwise noted, enzymes were purchased from Roche. The oligonucleotides (inserts) used for the preparation of the plasmids were obtained from the Oligonucleotide Synthesis Facility of the Beckman Institute at the California Institute of Technology. Sequencing of oligonucleotides was performed by the Sequence Analysis Facility, Division of Biology, California Institute of Technology. Radioactively labeled nucleotides were purchased from Perkin-Elmer. The footprinting experiments were performed according to published procedures<sup>[20]</sup> using the general rule of  $\epsilon = 8690 \text{ Lmol}^{-1} \text{ cm}^{-1}$  per ring in a polyamide for the quantification which turned out to also hold for U-pins. To quantify the gels they were exposed over night on Kodak storage phosphor screens (SO230, purchased from Molecular Dynamics). To obtain the images, the storage phosphor screen was scanned on a Typhoon 8600 phosphorimager from Molecular Dynamics. For the analysis the software ImageQuant (version 5.1) was used and the equilibrium affinity constants were determined according to previously published methods.<sup>[20]</sup> Abbreviations used: TMSE: trimethylsilylethyl, DCC: dicyclohexylcarbodiimide, HOBt: hydroxybenzotriazole, HBTU: 2-(1*H*-benzotriazole-1-yl)-1,1,3,3-tetramethyluronium hexa-fluorophosphate, DIEA: Hünig's base, Phth: *ortho*-phthalimide.

**U-pins 1a–f**: The U-pins for this study were all prepared according to reported solid phase synthesis protocols<sup>[7]</sup> on oxime resin (Novabiochem, catalogue number 01-64-002, 0.48 mmol g<sup>-1</sup>) and using the conditions detailed in Scheme 3. The U-pins were stored at –80 °C and the purity of this stock was rechecked at the end of this study.

**U-pin 1a**: <sup>1</sup>H NMR (300 MHz, DMSO, 25 °C, DMSO):  $\delta = 1.97$  (m, 2H; N(Py)CH<sub>2</sub>CH<sub>2</sub>CH<sub>2</sub>NH<sub>3</sub><sup>+</sup>), 2.18 (m, 2H; N(Py)CH<sub>2</sub>CH<sub>2</sub>CH<sub>2</sub>N(Im)), 2.66 (m, 8H; 2 CONHCH<sub>3</sub>+N(Py)CH<sub>2</sub>CH<sub>2</sub>CH<sub>2</sub>NH<sub>3</sub><sup>+</sup>), 3.75 (s, 3H; NMe), 3.76 (s, 3H; NMe), 3.82 (s, 3H; NMe), 3.83 (s, 3H; NMe), 3.99 (s, 3H; NMe), 4.30–4.32 (m, 4H; N(Py)CH<sub>2</sub>CH<sub>2</sub>CH<sub>2</sub>NH<sub>3</sub><sup>+</sup>+N(Py)CH<sub>2</sub>CH<sub>2</sub>CH<sub>2</sub>N(Im)), 4.46 (m, 2H; N(Py)CH<sub>2</sub>CH<sub>2</sub>CH<sub>2</sub>N(Im)), 6.79–7.57 (m; arom. H), 7.64 (m, 3H; NH<sub>3</sub><sup>+</sup>), 7.93–7.97 (m, 2H; 2 CONHMe), 9.72 (s, 1H; amide NH), 9.89 (s, 1H; amide NH), 9.96 (s, 1H; amide NH), 10.06 (s, 1H; amide NH), 10.42 (s, 1H; amide NH), 10.50 (s, 1H; amide NH); analytical HPLC:  $t_R = 18.87$  min; preparative HPLC:  $t_R = 46$  min; UV/Vis (H<sub>2</sub>O):  $\lambda_{\text{max}} = 244$ , 317 nm; MS (MALDI):  $m/z$ : calcd for C<sub>50</sub>H<sub>58</sub>N<sub>20</sub>O<sub>8</sub>: 1066.48; found: 1105.40 [M+K]<sup>+</sup>, 1089.43 [M+Na]<sup>+</sup>, 1067.44 [M+H]<sup>+</sup>.

**U-pin 1b**: <sup>1</sup>H NMR (300 MHz, DMSO, 25 °C, DMSO):  $\delta = 1.69$  (m, 4H; N(Py)CH<sub>2</sub>CH<sub>2</sub>CH<sub>2</sub>CH<sub>2</sub>N(Im)), 1.98 (m, 2H; N(Py)CH<sub>2</sub>CH<sub>2</sub>CH<sub>2</sub>NH<sub>3</sub><sup>+</sup>), 2.67 (m, 8H; 2 CONHCH<sub>3</sub>+N(Py)CH<sub>2</sub>CH<sub>2</sub>CH<sub>2</sub>NH<sub>3</sub><sup>+</sup>), 3.78 (s, 3H; NMe), 3.82 (s, 3H; NMe), 3.83 (s, 3H; NMe), 4.00 (s, 6H; 2NMe), 4.29 (m, 2H; N(Py)CH<sub>2</sub>CH<sub>2</sub>CH<sub>2</sub>CH<sub>2</sub>N(Im)), 4.35 (m, 2H; N(Py)CH<sub>2</sub>CH<sub>2</sub>CH<sub>2</sub>NH<sub>3</sub><sup>+</sup>),

Table 2. Equilibrium association constants [M<sup>-1</sup>] obtained in DNase I footprinting experiments with the *EcoRI*/*PvuII* restriction fragment of the plasmid pAH2 and the polyamides **1b**, **d–f** and **2** (see also Figures 6–8). All experiments were performed at least three times. Given are the average values and the standard deviations (in brackets).

Polyamide	5'-TGGTCA-3'	5'-TGGTCT-3'	5'-TGGTCC-3'	5'-TGGTCG-3'
<b>1b</b> ( $n = 4$ , R = CONHMe)	$6.3 \times 10^9$ (1.5)	$8.9 \times 10^9$ (1.4)	$2.4 \times 10^9$ (0.3)	$1.8 \times 10^8$ (0.1)
<b>1d</b> ( $n = 6$ , R = CONHMe)	$4.1 \times 10^9$ (0.9)	$6.5 \times 10^9$ (1.4)	$2.0 \times 10^9$ (1.0)	$2.0 \times 10^8$ (0.5)
<b>1e</b> ( $n = 6$ , R = CONH <sub>2</sub> )	$2.6 \times 10^9$ (0.9)	$2.6 \times 10^9$ (1.0)	$2.8 \times 10^9$ (1.2)	$4.1 \times 10^8$ (1.5)
<b>1f</b> ( $n = 6$ , R = H)	$2.3 \times 10^8$ (0.4)	$4.4 \times 10^8$ (0.5)	$2.9 \times 10^8$ (0.8)	$1.8 \times 10^8$ (0.2)
<b>2</b> (hairpin)	$1.3 \times 10^{10}$ (0.1)	$1.4 \times 10^{10}$ (0.1)	$1.5 \times 10^9$ (0.2)	$< 5 \times 10^7$

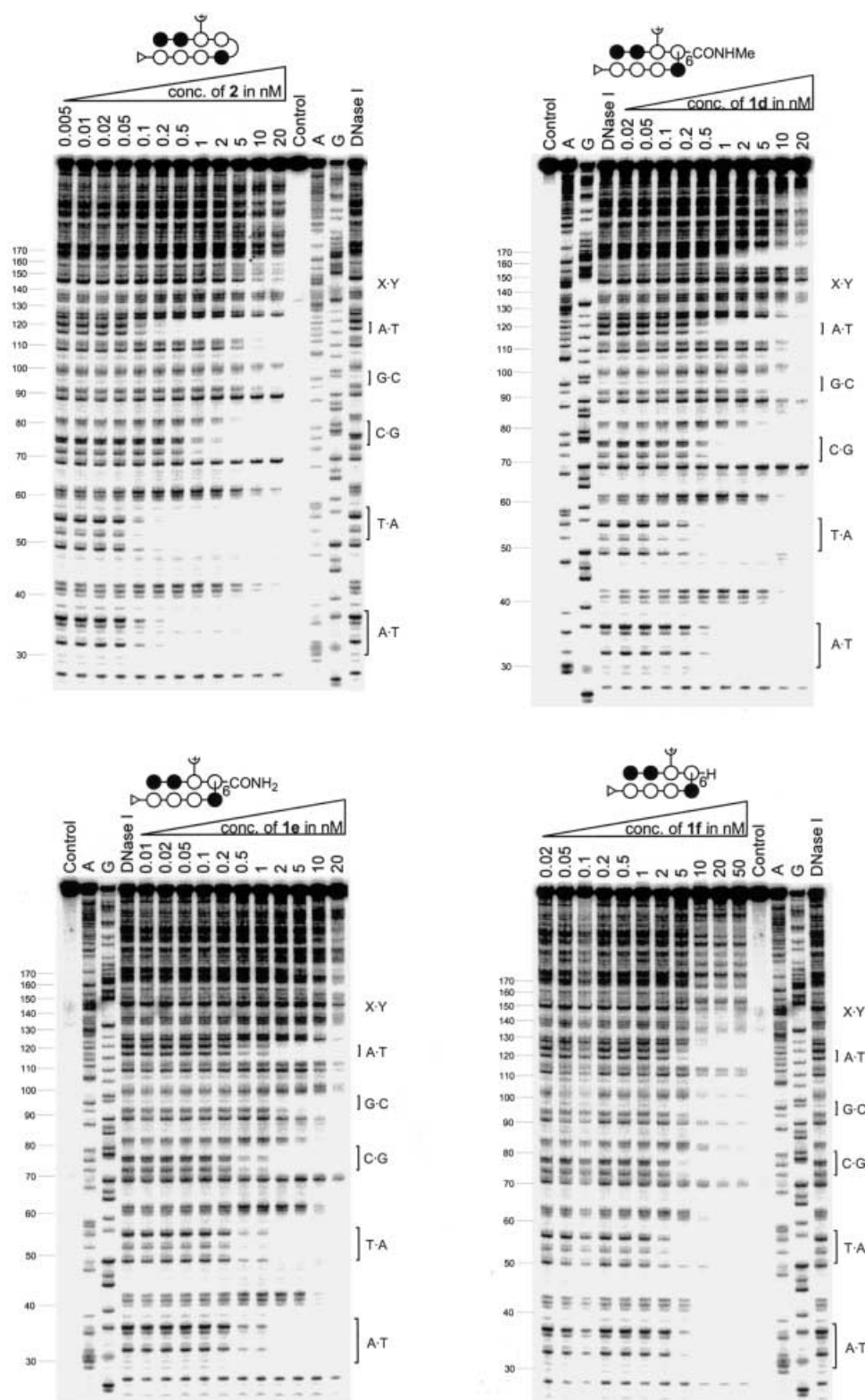

Figure 7. Results of DNase I footprinting experiments with the *EcoRI/PvuII* restriction fragment of the plasmid pAH2 (see Figure 6) and the polyamides **1d–f** and **2**. The numbers indicate the base-pair position and correspond to those in Figure 6.

4.44 (m, 2H; N(Py)CH<sub>2</sub>CH<sub>2</sub>CH<sub>2</sub>CH<sub>2</sub>N(Im)), 6.79–7.57 (m; arom. H), 7.65 (m, 3H; NH<sub>3</sub><sup>+</sup>), 7.90–7.95 (m, 2H; 2 CONHMe), 9.70 (s, 1H; amide NH), 9.88 (s, 1H; amide NH), 9.94 (s, 1H; amide NH), 10.02 (s, 1H; amide NH), 10.40 (s, 1H; amide NH), 10.44 (s, 1H; amide NH); analytical HPLC:  $t_R$  = 19.58 min; preparative HPLC:  $t_R$  = 50 min; UV/Vis (H<sub>2</sub>O):  $\lambda_{max}$  ( $\epsilon$ ) = 250 (4.67 × 10<sup>4</sup>), 312 nm (6.91 × 10<sup>4</sup> L mol<sup>-1</sup> cm<sup>-1</sup>); MS (MALDI):  $m/z$ : calcd

for C<sub>51</sub>H<sub>60</sub>N<sub>20</sub>O<sub>8</sub>: 1080.49; found: 1119.50 [M+K]<sup>+</sup>, 1103.47 [M+Na]<sup>+</sup>, 1081.51 [M+H]<sup>+</sup>.

**U-pin 1c**: <sup>1</sup>H NMR (300 MHz, DMSO, 25 °C, DMSO):  $\delta$  = 1.21 (m, 2H; N(Py)CH<sub>2</sub>CH<sub>2</sub>CH<sub>2</sub>CH<sub>2</sub>CH<sub>2</sub>N(Im)), 1.66 (m, 2H; N(Py)CH<sub>2</sub>CH<sub>2</sub>CH<sub>2</sub>CH<sub>2</sub>CH<sub>2</sub>N(Im)), 1.75 (m, 2H; N(Py)CH<sub>2</sub>CH<sub>2</sub>CH<sub>2</sub>CH<sub>2</sub>CH<sub>2</sub>N(Im)), 1.96



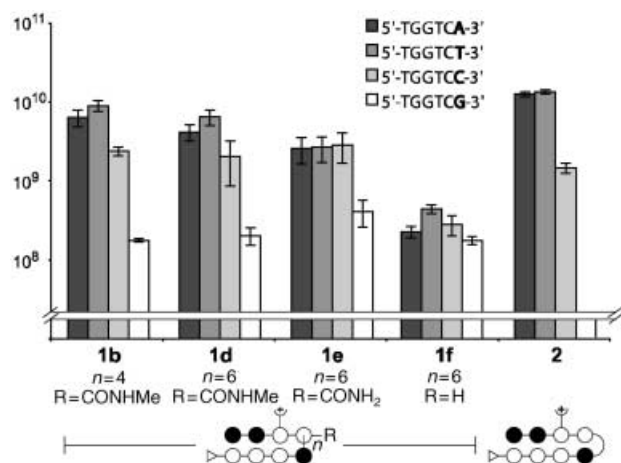

Figure 8. Graphical representation of the binding affinities of the polyamides **1b**, **d–f** and **2** to the respective binding sites on the *EcoRI/PvuII* restriction fragment of pAH2. For the numerical values see Table 2.

(m, 2H; N(Py)CH<sub>2</sub>CH<sub>2</sub>CH<sub>2</sub>NH<sub>3</sub><sup>+</sup>), 2.67 (m, 8H; 2CONHCH<sub>3</sub>+N(Py)CH<sub>2</sub>CH<sub>2</sub>CH<sub>2</sub>NH<sub>3</sub><sup>+</sup>), 3.78 (s, 3H; NMe), 3.82 (s, 3H; NMe), 3.83 (s, 3H; NMe), 3.99 (s, 6H; 2NMe), 4.24 (m, 2H; N(Py)CH<sub>2</sub>CH<sub>2</sub>CH<sub>2</sub>CH<sub>2</sub>CH<sub>2</sub>N(Im)), 4.35 (m, 2H; N(Py)CH<sub>2</sub>CH<sub>2</sub>CH<sub>2</sub>NH<sub>3</sub><sup>+</sup>), 4.40 (m, 2H; N(Py)CH<sub>2</sub>CH<sub>2</sub>CH<sub>2</sub>CH<sub>2</sub>CH<sub>2</sub>N(Im)), 6.78–7.58 (m; arom. H), 7.66 (m, 3H; NH<sub>3</sub><sup>+</sup>), 7.93 (m, 2H; 2CONHMe), 9.72 (s, 1H; amide NH), 9.89 (s, 1H; amide NH), 9.95 (s, 1H; amide NH), 10.03 (s, 1H; amide NH), 10.42 (s, 1H; amide NH), 10.46 (s, 1H; amide NH); analytical HPLC: *t*<sub>R</sub> = 20.18 min; preparative HPLC: *t*<sub>R</sub> = 54 min; UV/Vis (H<sub>2</sub>O): λ<sub>max</sub> (ε) = 244, 311 nm; MS (MALDI): *m/z*: calcd for C<sub>52</sub>H<sub>62</sub>N<sub>20</sub>O<sub>8</sub>: 1094.51; found: 1138.48 [M+K]<sup>+</sup>, 1117.51 [M+Na]<sup>+</sup>, 1095.55 [M+H]<sup>+</sup>.

**U-pin 1d**: <sup>1</sup>H NMR (300 MHz, DMSO, 25 °C, DMSO): δ = 1.23 (m, 4H; N(Py)CH<sub>2</sub>CH<sub>2</sub>CH<sub>2</sub>CH<sub>2</sub>CH<sub>2</sub>CH<sub>2</sub>N(Im)), 1.61 (m, 2H; N(Py)CH<sub>2</sub>CH<sub>2</sub>CH<sub>2</sub>CH<sub>2</sub>CH<sub>2</sub>CH<sub>2</sub>CH<sub>2</sub>N(Im)), 1.73 (m, 2H; N(Py)CH<sub>2</sub>CH<sub>2</sub>CH<sub>2</sub>CH<sub>2</sub>CH<sub>2</sub>CH<sub>2</sub>CH<sub>2</sub>N(Im)), 1.97 (m, 2H; N(Py)CH<sub>2</sub>CH<sub>2</sub>CH<sub>2</sub>CH<sub>2</sub>NH<sub>3</sub><sup>+</sup>), 2.67 (m, 8H; 2CONHCH<sub>3</sub>+N(Py)CH<sub>2</sub>CH<sub>2</sub>CH<sub>2</sub>CH<sub>2</sub>NH<sub>3</sub><sup>+</sup>), 3.78 (s, 3H; NMe), 3.82 (s, 3H; NMe), 3.83 (s, 3H; NMe), 3.99 (s, 6H; 2NMe), 4.22 (m, 2H; N(Py)CH<sub>2</sub>CH<sub>2</sub>CH<sub>2</sub>CH<sub>2</sub>CH<sub>2</sub>CH<sub>2</sub>N(Im)), 4.35 (m, 2H; N(Py)CH<sub>2</sub>CH<sub>2</sub>CH<sub>2</sub>CH<sub>2</sub>CH<sub>2</sub>CH<sub>2</sub>NH<sub>3</sub><sup>+</sup>), 4.38 (m, 2H; N(Py)CH<sub>2</sub>CH<sub>2</sub>CH<sub>2</sub>CH<sub>2</sub>CH<sub>2</sub>CH<sub>2</sub>N(Im)), 6.76–7.58 (m; arom. H), 7.65 (m, 3H; NH<sub>3</sub><sup>+</sup>), 7.92 (m, 2H; 2CONHMe), 9.72 (s, 1H; amide NH), 9.90 (s, 1H; amide NH), 9.96 (s, 1H; amide NH), 10.03 (s, 1H; amide NH), 10.43 (s, 1H; amide NH), 10.47 (s, 1H; amide NH); analytical HPLC: *t*<sub>R</sub> = 22.28 min; preparative HPLC: *t*<sub>R</sub> = 73 min, gradient: 0% B (0 min), 0% B (5 min), 25% B (60 min), 35% B (90 min), 45% B (100 min), linear; UV/Vis (H<sub>2</sub>O): λ<sub>max</sub> (ε) = 252, 312 nm; MS (MALDI): *m/z*: calcd for C<sub>53</sub>H<sub>64</sub>N<sub>20</sub>O<sub>8</sub>: 1108.53; found: 1147.45 [M+K]<sup>+</sup>, 1131.49 [M+Na]<sup>+</sup>, 1109.53 [M+H]<sup>+</sup>.

**U-pin 1e**: <sup>1</sup>H NMR (300 MHz, DMSO, 25 °C, DMSO): δ = 1.24 (m, 4H; N(Py)CH<sub>2</sub>CH<sub>2</sub>CH<sub>2</sub>CH<sub>2</sub>CH<sub>2</sub>CH<sub>2</sub>N(Im)), 1.62 (m, 2H; N(Py)CH<sub>2</sub>CH<sub>2</sub>CH<sub>2</sub>CH<sub>2</sub>CH<sub>2</sub>CH<sub>2</sub>CH<sub>2</sub>N(Im)), 1.73 (m, 2H; N(Py)CH<sub>2</sub>CH<sub>2</sub>CH<sub>2</sub>CH<sub>2</sub>CH<sub>2</sub>CH<sub>2</sub>CH<sub>2</sub>N(Im)), 1.98 (m, 2H; N(Py)CH<sub>2</sub>CH<sub>2</sub>CH<sub>2</sub>CH<sub>2</sub>NH<sub>3</sub><sup>+</sup>), 2.68 (m, 6H; CONHCH<sub>3</sub>+N(Py)CH<sub>2</sub>CH<sub>2</sub>CH<sub>2</sub>NH<sub>3</sub><sup>+</sup>), 3.79 (s, 3H; NMe), 3.83 (s, 3H; NMe), 3.84 (s, 3H; NMe), 4.00 (s, 6H; 2NMe), 4.24 (m, 2H; N(Py)CH<sub>2</sub>CH<sub>2</sub>CH<sub>2</sub>CH<sub>2</sub>CH<sub>2</sub>CH<sub>2</sub>N(Im)), 4.36 (m, 2H; N(Py)CH<sub>2</sub>CH<sub>2</sub>CH<sub>2</sub>CH<sub>2</sub>NH<sub>3</sub><sup>+</sup>), 4.42 (m, 2H; N(Py)CH<sub>2</sub>CH<sub>2</sub>CH<sub>2</sub>CH<sub>2</sub>CH<sub>2</sub>CH<sub>2</sub>N(Im)), 6.79–7.58 (m; arom. H), 7.66 (m, 3H; NH<sub>3</sub><sup>+</sup>), 7.93 (m, H; CONHMe), 9.73 (s, 1H; amide NH), 9.90 (s, 1H; amide NH), 9.96 (s, 1H; amide NH), 10.01 (s, 1H; amide NH), 10.43 (s, 1H; amide NH), 10.47 (s, 1H; amide NH); analytical HPLC: *t*<sub>R</sub> = 21.15 min; preparative HPLC: *t*<sub>R</sub> = 70 min, gradient: 0% B (0 min), 0% B (5 min), 25% B (60 min), 35% B (90 min), 45% B (100 min), linear; UV/Vis (H<sub>2</sub>O): λ<sub>max</sub> (ε) = 252, 314 nm; MS (MALDI): *m/z*: calcd for C<sub>52</sub>H<sub>62</sub>N<sub>20</sub>O<sub>8</sub>: 1094.51; found: 1117.25 [M+Na]<sup>+</sup>, 1095.24 [M+H]<sup>+</sup>.

**U-pin 1f**: <sup>1</sup>H NMR (300 MHz, DMSO, 25 °C, DMSO): δ = 1.24 (m, 4H; N(Py)CH<sub>2</sub>CH<sub>2</sub>CH<sub>2</sub>CH<sub>2</sub>CH<sub>2</sub>CH<sub>2</sub>N(Im)), 1.64 (m, 2H; N(Py)CH<sub>2</sub>CH<sub>2</sub>CH<sub>2</sub>CH<sub>2</sub>CH<sub>2</sub>CH<sub>2</sub>CH<sub>2</sub>N(Im)), 1.72 (m, 2H; N(Py)CH<sub>2</sub>CH<sub>2</sub>CH<sub>2</sub>CH<sub>2</sub>CH<sub>2</sub>CH<sub>2</sub>CH<sub>2</sub>N(Im)), 1.97 (m, 2H; N(Py)CH<sub>2</sub>CH<sub>2</sub>CH<sub>2</sub>CH<sub>2</sub>NH<sub>3</sub><sup>+</sup>), 2.67 (m, 6H; CONHCH<sub>3</sub>+N(Py)CH<sub>2</sub>CH<sub>2</sub>CH<sub>2</sub>NH<sub>3</sub><sup>+</sup>), 3.79 (m, 5H; NMe+N(Py)CH<sub>2</sub>

CH<sub>2</sub>CH<sub>2</sub>CH<sub>2</sub>CH<sub>2</sub>CH<sub>2</sub>N(Im)), 3.82 (s, 3H; NMe), 3.83 (s, 3H; NMe), 3.99 (s, 6H; 2NMe), 4.34 (m, 2H; N(Py)CH<sub>2</sub>CH<sub>2</sub>CH<sub>2</sub>CH<sub>2</sub>NH<sub>3</sub><sup>+</sup>), 4.42 (m, 2H; N(Py)CH<sub>2</sub>CH<sub>2</sub>CH<sub>2</sub>CH<sub>2</sub>CH<sub>2</sub>CH<sub>2</sub>CH<sub>2</sub>N(Im)), 6.06 (m, 1H; arom. H), 6.56 (m, 1H; arom. H), 6.79–7.58 (m; arom. H), 7.65 (m, 3H; NH<sub>3</sub><sup>+</sup>), 7.92 (m, H; CONHMe), 9.72 (s, 1H; amide NH), 9.88 (s, 1H; amide NH), 9.90 (s, 1H; amide NH), 9.95 (s, 1H; amide NH), 10.40 (s, 1H; amide NH), 10.47 (s, 1H; amide NH); analytical HPLC: *t*<sub>R</sub> = 22.93 min; preparative HPLC: *t*<sub>R</sub> = 76 min, gradient: 0% B (0 min), 0% B (5 min), 25% B (60 min), 35% B (90 min), 45% B (100 min), linear; UV/Vis (H<sub>2</sub>O): λ<sub>max</sub> (ε) = 250, 314 nm; MS (MALDI): *m/z*: calcd for C<sub>51</sub>H<sub>61</sub>N<sub>19</sub>O<sub>7</sub>: 1051.50; found: 1090.72 [M+K]<sup>+</sup>, 1074.72 [M+Na]<sup>+</sup>, 1052.80 [M+H]<sup>+</sup>.

**Hairpin-polyamide 2**: This compound was prepared according to reported solid phase synthesis strategies<sup>[7]</sup> on oxime resin (Novabiochem, catalogue number 01-64-002, 0.48 mmol g<sup>-1</sup>) and using the conditions detailed in Scheme 3. <sup>1</sup>H NMR (300 MHz, DMSO, 25 °C, DMSO): δ = 1.80 (m, 2H; NCH<sub>2</sub>CH<sub>2</sub>CH<sub>2</sub>CO (GABA)), 2.00 (m, 2H; N(Py)CH<sub>2</sub>CH<sub>2</sub>CH<sub>2</sub>NH<sub>3</sub><sup>+</sup>), 2.36 (t, <sup>3</sup>J(H,H) = 6.6 Hz, 2H; NCH<sub>2</sub>CH<sub>2</sub>CH<sub>2</sub>CO (GABA)), 2.68 (d, <sup>3</sup>J(H,H) = 4.4 Hz, 3H; CONHCH<sub>3</sub>), 2.76 (m, 2H; N(Py)CH<sub>2</sub>CH<sub>2</sub>CH<sub>2</sub>NH<sub>3</sub><sup>+</sup>), 3.20 (m, 2H; NCH<sub>2</sub>CH<sub>2</sub>CH<sub>2</sub>CO (GABA)), 3.54 (s, 3H; NMe), 3.80 (s, 3H; NMe), 3.81 (s, 3H; NMe), 3.84 (s, 3H; NMe), 3.86 (s, 3H; NMe), 3.96 (s, 3H; NMe), 4.01 (s, 3H; NMe), 4.38 (m, 2H; N(Py)CH<sub>2</sub>CH<sub>2</sub>CH<sub>2</sub>NH<sub>3</sub><sup>+</sup>), 6.81–7.67 (m; arom. H), 7.94 (d, <sup>3</sup>J(H,H) = 4.4 Hz, 1H; CONHCH<sub>3</sub>), 8.06 (m, 1H; NCH<sub>2</sub>CH<sub>2</sub>CH<sub>2</sub>CO (GABA)), 9.74 (s, 1H; amide NH), 9.92 (s, 1H; amide NH), 9.96 (s, 1H; amide NH), 10.00 (s, 1H; amide NH), 10.05 (s, 1H; amide NH), 10.29 (s, 1H; amide NH), 10.45 (s, 1H; amide NH); analytical HPLC: *t*<sub>R</sub> = 19.30 min (column: Varian Microsorb MV 100-5C18, 250 × 4.6 mm); preparative HPLC: *t*<sub>R</sub> = 49.5 min; UV/Vis (H<sub>2</sub>O): λ<sub>max</sub> = 236, 314 nm; MS (MALDI): *m/z*: calcd for C<sub>52</sub>H<sub>61</sub>N<sub>21</sub>O<sub>9</sub>: 1123.50; found: 1162.40 [M+K]<sup>+</sup>, 1146.39 [M+Na]<sup>+</sup>, 1124.41 [M+H]<sup>+</sup>.

**2,2,2-Trichloro-1-(4-nitro-1H-pyrrol-2-yl)-ethanone (4)**: 2,2,2-Trichloro-1-(1H-pyrrol-2-yl)-ethanone (209 g, 0.984 mol) was dissolved in Ac<sub>2</sub>O (1 L) and the solution was cooled to -15 °C. Then fuming HNO<sub>3</sub> (113 mL) was added very carefully, so that the temperature of the reaction mixture was kept between -20 and -15 °C. After the addition was finished the temperature of the reaction mixture was slowly allowed to come to RT and stirring was continued over night. Then the mixture was poured into ice water. The precipitate was collected and dried. After coevaporating with toluene several times the residue was again dried and recrystallized from CHCl<sub>3</sub>/EtOH 95:5. Thus, compound **4** was isolated as beige solid (139 g, 0.540 mol, 55%). The spectroscopic data were in accord with literature data.<sup>[2]</sup>

**4-Nitro-1H-pyrrole-2-carboxylic-2-trimethylsilyl ethyl ester (5)**: NaH (0.8 g, 60%, 20.2 mmol, 0.2 equiv) was suspended in THF and 2-trimethylsilyl-ethanol (16 mL, 13.2 g, 111 mmol, 1.1 equiv) was slowly added. Then compound **4** (26 g, 101.0 mmol, 1 equiv) was dissolved in THF and slowly added. After stirring at RT for 14 h the reaction mixture was neutralized with conc. H<sub>2</sub>SO<sub>4</sub> and the solvent was evaporated. Then CH<sub>2</sub>Cl<sub>2</sub> (30 mL) and petroleum ether (80 mL) were added and the mixture was kept in a freezer for several hours. After filtration, compound **5** was isolated as a yellow powder (25.07 g, 97.8 mmol, 97%). The spectroscopic data were in accord with literature data.<sup>[2]</sup>

**4-tert-Butoxycarbonylamino-1H-pyrrole-2-carboxylic-2-trimethylsilyl ethyl ester (6)**: In a 1 L bomb compound **5** (75 g, 293 mmol, 1.0 equiv) was suspended in EtOAc (500 mL) and EtOH (150 mL) and the suspension was purged with Ar. Then Pd/C (30 g, 10%) was added and the bomb was pressurized with H<sub>2</sub> (25 bar). After 3 h the reaction mixture was filtered through Celite and most of the solvent was evaporated. Then an aqueous solution of NaHCO<sub>3</sub> and Boc<sub>2</sub>O (96 g, 439.5 mmol, 1.5 equiv) were added and the mixture was stirred at RT for 1 h. After separation of the phases the aqueous layer was extracted twice with EtOAc. The combined organic phases were dried with MgSO<sub>4</sub> and the solvent was evaporated, affording a yellowish powder which was dissolved in CH<sub>2</sub>Cl<sub>2</sub> (100 mL), followed by addition of petroleum ether (800 mL). After keeping this mixture in a freezer for several hours, filtration afforded compound **6** as a colorless powder (80.3 g, 249 mmol, 84%). The spectroscopic data was in accord with literature data.<sup>[2]</sup>

**Compounds 7a–c**: Detailed example for the preparation of compound **7b**: NaH (20 g, 60%, 0.499 mol, 1.00 equiv) was suspended in THF (90 mL). Then a solution of imidazole (34 g, 0.499 mol, 1.00 equiv) in THF (200 mL) was slowly added. The suspension was heated to reflux and more THF

(80 mL) was added. After dissolving acetic 4-bromo-butyl ester (99.3 g, 0.509 mol, 1.02 equiv) in THF (100 mL) this solution was added to the reaction mixture. After heating to reflux for 20 h the reaction was allowed to cool to room temperature, H<sub>2</sub>O (1 mL) was added and the solvent was evaporated. The residue was partitioned between CH<sub>2</sub>Cl<sub>2</sub> and H<sub>2</sub>O and the aqueous phase was extracted twice with CH<sub>2</sub>Cl<sub>2</sub>. The combined organic layers were extracted with brine, dried with MgSO<sub>4</sub> and the solvent was evaporated. Then the remaining orange oil was distilled under vacuum. To remove traces of mineral oil the product was dissolved in dilute aqueous HCl and the solution was extracted with petroleum ether. After neutralization with K<sub>2</sub>CO<sub>3</sub> the aqueous phase was extracted with CH<sub>2</sub>Cl<sub>2</sub> (three times). The combined organic layers were dried with MgSO<sub>4</sub> and the solvent was evaporated to obtain spectroscopically pure compound **7b** as colorless liquid (76.1 g, 0.418 mol, 84%). <sup>1</sup>H NMR (300 MHz, CDCl<sub>3</sub>, 25 °C, CHCl<sub>3</sub>): δ = 1.58–1.67 (m, 2H; CH<sub>2</sub>), 1.81–1.91 (m, 2H; CH<sub>2</sub>), 2.04 (s, 3H; OAc), 3.99 (t, <sup>3</sup>J(H,H) = 7.1 Hz, 2H; CH<sub>2</sub>), 4.07 (t, <sup>3</sup>J(H,H) = 6.6 Hz, 2H; CH<sub>2</sub>), 6.92 (s, 1H; arom. H), 7.08 (s, 1H; arom. H), 7.58 (s, 1H; arom. H); <sup>13</sup>C NMR (75 MHz, CDCl<sub>3</sub>, 25 °C, CDCl<sub>3</sub>): δ = 21.01, 25.75, 27.78, 46.62, 63.45, 118.62, 129.20, 136.84, 170.82; IR (CHCl<sub>3</sub>):  $\tilde{\nu}$  = 2966 (m), 1733 (s), 1508 (m), 1451 (w), 1390 (w), 1367 (m), 1224 (s), 1111 (w), 1078 (m), 1049 (m), 910 cm<sup>-1</sup> (w); HR-MS (ESI): calcd for C<sub>9</sub>H<sub>14</sub>N<sub>2</sub>O<sub>2</sub>: 182.1055; found: 183.113 [M+H]<sup>+</sup>.

**Compound 7a:** Obtained similarly; the acetic 3-bromo-propyl ester used was obtained by diluting 3-bromo-propanol (50 g, 0.36 mol, 1 equiv) with CH<sub>2</sub>Cl<sub>2</sub> (300 mL) and adding a preformed mixture of Ac<sub>2</sub>O (34 mL, 0.36 mol, 1 equiv) and Et<sub>3</sub>N (50 mL, 0.36 mol, 1 equiv). After stirring at RT for 20 min an aqueous solution of NaHCO<sub>3</sub> was added and the phases were separated. The organic layer was extracted once more with aqueous NaHCO<sub>3</sub> and then with brine. After drying with MgSO<sub>4</sub> the solvent was evaporated and the residue distilled under reduced pressure, affording acetic 3-bromo-propyl ester as colorless oil (53.0 g, 0.292 mol, 81%). Then, using imidazole (32.0 g, 0.470 mol, 1 equiv), acetic 3-bromo-propyl ester (86.7 g, 0.479 mol, 1.02 equiv) and NaH (18.8 g, 60%, 0.470 mol, 1 equiv), compound **7a** was isolated as slightly yellowish oil (49.1 g, 0.292 mol, 62%). *R*<sub>f</sub> (hexane/acetone 3:2) = 0.38; <sup>1</sup>H NMR (300 MHz, CDCl<sub>3</sub>, 25 °C, CHCl<sub>3</sub>): δ = 2.03 (s, 3H; OAc), 2.07 (quint., <sup>3</sup>J(H,H) = 6.0 Hz, 2H; CH<sub>2</sub>CH<sub>2</sub>CH<sub>2</sub>), 4.03 (m, 4H; CH<sub>2</sub>CH<sub>2</sub>CH<sub>2</sub>), 6.89 (d, <sup>3</sup>J(H,H) = 1.1 Hz, 1H; arom. H), 7.04 (d, <sup>3</sup>J(H,H) = 1.1 Hz, 1H; arom. H), 7.47 (s, 1H; arom. H); <sup>13</sup>C NMR (75 MHz, CDCl<sub>3</sub>, 25 °C, CDCl<sub>3</sub>): δ = 20.84, 30.16, 43.68, 60.82, 118.60, 129.45, 136.93, 170.52; IR (CHCl<sub>3</sub>):  $\tilde{\nu}$  = 2968 (m), 1738 (s), 1508 (m), 1454 (w), 1392 (w), 1369 (m), 1225 (s), 1110 (m), 1079 (m), 1050 (m), 910 (m), 818 cm<sup>-1</sup> (m); HR-MS (EI): calcd for C<sub>8</sub>H<sub>12</sub>N<sub>2</sub>O<sub>2</sub>: 168.0899; found: 168.0891 [M]<sup>+</sup>.

**Compound 7c:** Obtained similarly, using imidazole (40.0 g, 0.587 mol, 1 equiv), acetic 5-bromo-pentyl ester (125.21 g, 0.599 mol, 1.02 equiv) and NaH (23.5 g, 60%, 0.587 mol, 1 equiv), and isolated as colorless oil (77.5 g, 0.395 mol, 67%). <sup>1</sup>H NMR (300 MHz, CDCl<sub>3</sub>, 25 °C, CHCl<sub>3</sub>): δ = 1.25–1.38 (m, 2H; CH<sub>2</sub>), 1.58–1.67 (m, 2H; CH<sub>2</sub>), 1.73–1.84 (m, 2H; CH<sub>2</sub>), 2.01 (s, 3H; OAc), 3.93 (dt, <sup>3</sup>J(H,H) = 1.6, 7.1 Hz, 2H; CH<sub>2</sub>), 4.02 (dt, <sup>3</sup>J(H,H) = 1.6, 6.6 Hz, 2H; CH<sub>2</sub>), 6.88 (dd, <sup>3</sup>J(H,H) = 1.6, 2.7 Hz, 1H; arom. H), 7.03 (s, 1H; arom. H), 7.46 (s, 1H; arom. H); <sup>13</sup>C NMR (75 MHz, CDCl<sub>3</sub>, 25 °C, CDCl<sub>3</sub>): δ = 20.98, 23.03, 28.06, 30.68, 46.81, 63.87, 118.59, 129.20, 136.84, 170.85; IR (CHCl<sub>3</sub>):  $\tilde{\nu}$  = 2946 (m), 2867 (s), 1731 (s), 1509 (m), 1453 (w), 1391 (w), 1367 (m), 1245 (s), 1110 (m), 1078 (m), 1049 (m), 910 cm<sup>-1</sup> (w).

**Compound 7d:** Triphenylphosphine (33.9 g, 129 mmol, 1 equiv) and imidazole (8.8 g, 129 mmol, 1 equiv) were dissolved in CH<sub>2</sub>Cl<sub>2</sub>. After cooling with an ice bath, I<sub>2</sub> (32.8 g, 129 mmol, 1 equiv) was slowly added. After the addition was finished, the reaction mixture was stirred for another 10 min at RT. Then acetic 6-hydroxy-hexyl ester (20.69 g, 129 mmol, 1 equiv)—prepared according to a literature procedure<sup>[12]</sup>—was diluted with CH<sub>2</sub>Cl<sub>2</sub> and slowly added to the previous reaction mixture, which had again been cooled with an ice bath. After the addition was finished the reaction mixture was stirred for another 10 min at RT and extracted twice with an aqueous solution of Na<sub>2</sub>S<sub>2</sub>O<sub>3</sub> and then with brine. The organic layer was then dried with MgSO<sub>4</sub> and the solvent was evaporated, affording a colorless solid (67.9 g) which was dissolved in THF. Then NaH (5.0 g, 60%, 125 mmol, 0.97 equiv) was washed with hexane and suspended in THF. After imidazole (8.4 g, 125 mmol, 0.97 equiv) had been dissolved in THF and added to the NaH suspension, the slurry was heated to reflux and the THF solution of the iodide was added. Heating (reflux) was continued for 2 h. Then the reaction mixture was allowed to cool to RT

and stirred over night. After quenching with H<sub>2</sub>O (1 mL), the solvent was evaporated and H<sub>2</sub>O and CH<sub>2</sub>Cl<sub>2</sub> were added. The aqueous layer was extracted twice with CH<sub>2</sub>Cl<sub>2</sub>. The combined organic layers were extracted with brine. Then most of the solvent was evaporated and aqueous HCl (1M) was added. After separation of the layers the organic phase was extracted twice with dilute aqueous HCl. The combined aqueous layers were neutralized with K<sub>2</sub>CO<sub>3</sub> and the product was extracted three times with CH<sub>2</sub>Cl<sub>2</sub>. After drying with MgSO<sub>4</sub> the solvent was evaporated, affording compound **7d** as slightly brownish oil (22.8 g, 108 mmol, 84%). <sup>1</sup>H NMR (300 MHz, CDCl<sub>3</sub>, 25 °C, CHCl<sub>3</sub>): δ = 1.32–1.38 (m, 4H; CH<sub>2</sub>), 1.62 (quint., <sup>3</sup>J(H,H) = 6.6 Hz, 2H; CH<sub>2</sub>), 1.79 (quint., <sup>3</sup>J(H,H) = 7.1 Hz, 2H; CH<sub>2</sub>), 2.04 (s, 3H; OAc), 3.94 (t, <sup>3</sup>J(H,H) = 7.1 Hz, 2H; CH<sub>2</sub>), 4.04 (t, <sup>3</sup>J(H,H) = 6.6 Hz, 2H; CH<sub>2</sub>), 6.91 (s, 1H; arom. H), 7.06 (s, 1H; arom. H), 7.46 (s, 1H; arom. H); <sup>13</sup>C NMR (75 MHz, CDCl<sub>3</sub>, 25 °C, CDCl<sub>3</sub>): δ = 21.01, 25.49, 26.23, 28.42, 30.98, 46.87, 64.16, 118.58, 129.28, 136.87, 170.93; IR (CHCl<sub>3</sub>):  $\tilde{\nu}$  = 2942 (s), 2863 (m), 1732 (s), 1509 (s), 1465 (m), 1390 (m), 1368 (s), 1251 (s), 1110 (m), 1078 (s), 910 cm<sup>-1</sup> (m); HR-MS (ESI): calcd for C<sub>11</sub>H<sub>18</sub>N<sub>2</sub>O<sub>2</sub>: 210.1368; found: 211.1441 [M+H]<sup>+</sup>.

**Compounds 8a–d:** Detailed example for the preparation of compound **8b**: Cl<sub>3</sub>CCOCl (20.6 mL, 33.6 g, 0.185 mol, 1.1 equiv) was diluted with CH<sub>2</sub>Cl<sub>2</sub>. After cooling the solution to 5 °C, compound **7b** (30.6 g, 0.168 mol, 1 equiv), diluted with CH<sub>2</sub>Cl<sub>2</sub> (50 mL), was slowly added so that the temperature did not exceed 10 °C. After stirring for 10 min at 5 °C, Et<sub>3</sub>N (23.4 mL, 0.168 mol, 1 equiv) was slowly added so that the temperature of the reaction mixture did not exceed 15 °C. After the addition was finished the reaction mixture is diluted with CH<sub>2</sub>Cl<sub>2</sub> and stirred at RT for 10 min. Then the solvent was evaporated and EtOAc and an aqueous solution of NaHCO<sub>3</sub> were added. The organic layer was again extracted with aqueous NaHCO<sub>3</sub> and then with a 5% aqueous solution of citric acid. After drying the organic layer with MgSO<sub>4</sub>, the solvent was evaporated, affording the crude product as brownish oil (45.6 g, 0.139 mol, 83%). This product was sufficiently pure for the following reactions. Since the product decomposes very fast (even when kept at –20 °C) it was always immediately used for further reactions. To obtain an spectroscopically pure sample, the crude product was dissolved in CH<sub>2</sub>Cl<sub>2</sub> and filtered through silica gel, affording a yellowish oil. *R*<sub>f</sub> (hexane/acetone 3:2) = 0.56; <sup>1</sup>H NMR (300 MHz, CDCl<sub>3</sub>, 25 °C, TMS): δ = 1.72 (m, 2H; CH<sub>2</sub>), 1.90 (m, 2H; CH<sub>2</sub>), 2.07 (s, 3H; OAc), 4.12 (t, <sup>3</sup>J(H,H) = 6.0 Hz, 2H; CH<sub>2</sub>), 4.45 (t, <sup>3</sup>J(H,H) = 7.1 Hz, 2H; CH<sub>2</sub>), 7.23 (s, 1H; arom. H), 7.38 (s, 1H; arom. H); <sup>13</sup>C NMR (75 MHz, CDCl<sub>3</sub>, 25 °C, CDCl<sub>3</sub>): δ = 21.00, 25.67, 27.59, 49.20, 63.40, 127.49, 130.62, 135.35, 170.84, 171.88; IR (CHCl<sub>3</sub>):  $\tilde{\nu}$  = 3002 (m), 2966 (m), 1732 (s), 1698 (m), 1662 (s), 1583 (w), 1502 (m), 1466 (m), 1438 (w), 1387 (s), 1366 (s), 1394 (m), 1246 (s), 1170 (w), 1120 (w), 1050 (w), 916 cm<sup>-1</sup> (w).

**Compound 8a:** Obtained similarly, using compound **7a** (10 g, 59 mmol, 1 equiv), Cl<sub>3</sub>CCOCl (7.2 mL, 11.8 g, 65 mmol, 1.1 equiv) and Et<sub>3</sub>N (8.3 mL, 59 mmol, 1 equiv) and isolated as slightly yellowish liquid (11.8 g, 40 mmol, 67%). *R*<sub>f</sub> (hexane/acetone 3:2) = 0.52; <sup>1</sup>H NMR (300 MHz, CDCl<sub>3</sub>, 25 °C, CHCl<sub>3</sub>): δ = 2.06 (s, 3H; OAc), 2.17 (quint., <sup>3</sup>J(H,H) = 6.6 Hz, 2H; CH<sub>2</sub>), 4.11 (t, <sup>3</sup>J(H,H) = 6.0 Hz, 2H; CH<sub>2</sub>), 4.51 (t, <sup>3</sup>J(H,H) = 7.1 Hz, 2H; CH<sub>2</sub>), 7.22 (s, 1H; arom. H), 7.37 (s, 1H; arom. H); <sup>13</sup>C NMR (75 MHz, CDCl<sub>3</sub>, 25 °C, CDCl<sub>3</sub>): δ = 20.93, 29.76, 46.68, 60.86, 94.76, 127.71, 130.67, 135.42, 170.62, 171.90; IR (CHCl<sub>3</sub>):  $\tilde{\nu}$  = 2998 (m), 1738 (s), 1699 (s), 1468 (m), 1387 (s), 1369 (m), 1242 (s), 1162 (w), 1078 (w), 1049 (m), 1018 (m), 918 cm<sup>-1</sup> (w).

**Compound 8c:** Obtained similarly, using compound **7c** (77.5 g, 0.395 mol, 1 equiv), Cl<sub>3</sub>CCOCl (79.1 g, 0.435 mol, 1.1 equiv) and Et<sub>3</sub>N (55 mL, 0.395 mol, 1 equiv) and isolated as yellowish liquid (132.2 g, 0.387 mol, 98%). *R*<sub>f</sub> (hexane/acetone 3:2) = 0.57; <sup>1</sup>H NMR (300 MHz, CDCl<sub>3</sub>, 25 °C, CHCl<sub>3</sub>): δ = 1.45 (m, 2H; CH<sub>2</sub>), 1.71 (m, 2H; CH<sub>2</sub>), 1.88 (m, 2H; CH<sub>2</sub>), 2.05 (s, 3H; OAc), 4.07 (t, <sup>3</sup>J(H,H) = 6.6 Hz, 2H; CH<sub>2</sub>), 4.44 (t, <sup>3</sup>J(H,H) = 7.7 Hz, 2H; CH<sub>2</sub>), 7.27 (s, 1H; arom. H), 7.36 (s, 1H; arom. H); <sup>13</sup>C NMR (75 MHz, CDCl<sub>3</sub>, 25 °C, CDCl<sub>3</sub>): δ = 20.81, 22.80, 27.88, 30.33, 49.26, 63.68, 94.73, 127.44, 130.31, 135.04, 170.60, 171.49; IR (CHCl<sub>3</sub>):  $\tilde{\nu}$  = 2998 (m), 2958 (m), 2866 (w), 1732 (s), 1699 (s), 1662 (m), 1468 (m), 1437 (w), 1387 (s), 1367 (m), 1250 (s), 1167 (w), 1068 (w), 1047 (m), 1020 (m), 918 cm<sup>-1</sup> (w).

**Compound 8d:** Obtained similarly, using compound **7d** (1.87 g, 8.89 mmol, 1 equiv), Cl<sub>3</sub>CCOCl (1.09 mL, 9.78 mmol, 1.1 equiv) and Et<sub>3</sub>N (1.24 mL, 8.89 mmol, 1 equiv), and isolated as yellowish oil (3.16g, 8.89 mmol, 99%). *R*<sub>f</sub> (hexane/acetone 3:2) = 0.50; <sup>1</sup>H NMR (300 MHz, CDCl<sub>3</sub>, 25 °C, CHCl<sub>3</sub>): δ = 1.41 (m, 4H; 2CH<sub>2</sub>), 1.65 (m, 2H; CH<sub>2</sub>), 1.85 (m, 2H; CH<sub>2</sub>), 2.05 (s, 3H; OAc), 4.06 (t, <sup>3</sup>J(H,H) = 6.6 Hz, 2H; CH<sub>2</sub>), 4.41 (t, <sup>3</sup>J(H,H) = 7.7 Hz, 2H; CH<sub>2</sub>), 7.22 (s, 1H; arom. H), 7.37 (s, 1H; arom. H); <sup>13</sup>C NMR (75 MHz,

$\text{CDCl}_3$ , 25 °C,  $\text{CDCl}_3$ ):  $\delta$  = 21.02, 25.49, 26.15, 28.43, 30.81, 49.57, 64.14, 94.82, 127.46, 130.47, 135.28, 170.92, 171.76; IR ( $\text{CHCl}_3$ ):  $\tilde{\nu}$  = 2996 (m), 2942 (s), 2863 (m), 1732 (s), 1698 (s), 1469 (s), 1438 (m), 1387 (s), 1368 (s), 1308 (m), 1243 (s), 1020 (s), 975  $\text{cm}^{-1}$  (s); MS (ESI):  $m/z$  (%): 355.2 (85) [ $M+H$ ]<sup>+</sup>, 313.2 (100), 295.2 (25), 213.1 (85).

**Compounds 9a–d:** Detailed example for the preparation of compound **9b**: A solution of NaOEt was prepared by adding Na (3.18 g, 0.138 mol, 1 equiv) to EtOH (200 mL). After all Na had reacted, a solution of freshly prepared compound **8b** (45.3 g, 0.138 mol, 1 equiv) in EtOH was added and the reaction mixture was stirred over night at RT. Then the reaction mixture was carefully neutralized with conc.  $\text{H}_2\text{SO}_4$  and the solvent was evaporated. After adding EtOAc and a saturated solution of  $\text{NaHCO}_3$  the layers were separated and the aqueous layer was extracted twice with EtOAc. The organic layers were combined, dried with  $\text{MgSO}_4$  and the solvent was evaporated, affording compound **9b** (24.8 g, 0.117 mol, 85 %) as an orange oil which could be used without any further purification. To obtain a spectroscopically pure sample, the crude product was filtered through silica gel using hexane/acetone 1:4 as solvent, affording a yellowish oil.  $R_f$  (hexane/acetone 1:3) = 0.47;  $^1\text{H}$  NMR (300 MHz,  $\text{CDCl}_3$ , 25 °C, TMS):  $\delta$  = 1.42 (t,  $^3J(\text{H,H})$  = 7.1 Hz, 3H;  $\text{OCH}_2\text{CH}_3$ ), 1.60 (quint.,  $^3J(\text{H,H})$  = 6.6 Hz, 2H;  $\text{CH}_2$ ), 1.91 (quint.,  $^3J(\text{H,H})$  = 7.1 Hz, 2H;  $\text{CH}_2$ ), 3.20 (brs, 1H; OH), 3.66 (t,  $^3J(\text{H,H})$  = 6.0 Hz, 2H;  $\text{CH}_2\text{OH}$ ), 4.36–4.46 (m, 4H;  $\text{OCH}_2\text{CH}_3+\text{NCH}_2$ ), 7.11 (s, 1H; arom. H), 7.12 (s, 1H; arom. H);  $^{13}\text{C}$  NMR (75 MHz,  $\text{CDCl}_3$ , 25 °C,  $\text{CDCl}_3$ ):  $\delta$  = 14.15, 27.68, 29.21, 48.11, 61.23, 61.41, 125.02, 129.00, 135.64, 158.67; IR ( $\text{CHCl}_3$ ):  $\tilde{\nu}$  = 2984 (m), 1710 (s), 1470 (m), 1422 (m), 1386 (m), 1258 (s), 1156 (w), 1118 (s); HR-MS (MALDI): calcd for  $\text{C}_{10}\text{H}_{16}\text{N}_2\text{O}_3$ : 212.1161; found: 235.1051 [ $M+\text{Na}$ ]<sup>+</sup>, 213.1232 [ $M+H$ ]<sup>+</sup>.

**Compound 9a:** Obtained similarly, using Na (400 mg, 17.5 mmol, 1 equiv) and compound **8a** (5.2 g, 17.5 mmol, 1 equiv) and isolated as yellow oil (2.5 g, 13 mmol, 72 %).  $R_f$  (hexane/acetone 1:3) = 0.43;  $^1\text{H}$  NMR (300 MHz,  $\text{CDCl}_3$ , 25 °C,  $\text{CHCl}_3$ ):  $\delta$  = 1.40 (t,  $^3J(\text{H,H})$  = 7.1 Hz, 3H;  $\text{OCH}_2\text{CH}_3$ ), 2.03 (quint.,  $^3J(\text{H,H})$  = 6.0 Hz, 2H;  $\text{CH}_2\text{CH}_2\text{CH}_2$ ), 3.61 (t,  $^3J(\text{H,H})$  = 6.0 Hz, 2H;  $\text{CH}_2\text{OH}$ ), 4.36 (quart.+brs,  $^3J(\text{H,H})$  = 7.1 Hz, 3H;  $\text{OCH}_2\text{CH}_3+\text{OH}$ ), 4.54 (t,  $^3J(\text{H,H})$  = 7.1 Hz, 2H;  $\text{NCH}_2$ ), 7.11 (s, 1H; arom. H), 7.18 (s, 1H; arom. H);  $^{13}\text{C}$  NMR (75 MHz,  $\text{CDCl}_3$ , 25 °C,  $\text{CDCl}_3$ ):  $\delta$  = 13.96, 33.39, 44.91, 57.76, 61.16, 125.47, 128.69, 135.53, 158.51; IR ( $\text{CDCl}_3$ ):  $\tilde{\nu}$  = 3626 (w), 3524 (w), 2964 (w), 1707 (s), 1473 (m), 1422 (s), 1386 (m), 1308 (m), 1257 (s), 1182 (w), 1157 (w), 1116 (s); HR-MS (MALDI): calcd for  $\text{C}_9\text{H}_{14}\text{N}_2\text{O}_3$ : 198.1004; found: 221.0895 [ $M+\text{Na}$ ]<sup>+</sup>, 199.1076 [ $M+H$ ]<sup>+</sup>.

**Compound 9c:** Obtained similarly, using Na (9.3 g, 0.404 mol, 1.05 equiv) and compound **8c** (132.2 g, 0.387 mmol, 1 equiv) and isolated as yellowish oil (79.1 g, 0.35 mol, 90 %).  $R_f$  (hexane/acetone 1:3) = 0.50;  $^1\text{H}$  NMR (300 MHz,  $\text{CDCl}_3$ , 25 °C, TMS):  $\delta$  = 1.43 (m, 5H;  $\text{OCH}_2\text{CH}_3$ ,  $\text{CH}_2$ ), 1.59 (quint.,  $^3J(\text{H,H})$  = 6.6 Hz, 2H;  $\text{CH}_2$ ), 1.82 (quint.,  $^3J(\text{H,H})$  = 7.7 Hz, 2H;  $\text{CH}_2$ ), 3.11 (brs, 1H; OH), 3.62 (t,  $^3J(\text{H,H})$  = 6.6 Hz; 2H;  $\text{CH}_2\text{OH}$ ), 4.36–4.43 (m, 4H;  $\text{OCH}_2\text{CH}_3+\text{NCH}_2$ ), 7.10 (s, 1H; arom. H), 7.13 (s, 1H; arom. H);  $^{13}\text{C}$  NMR (75 MHz,  $\text{CDCl}_3$ , 25 °C,  $\text{CDCl}_3$ ):  $\delta$  = 14.10, 22.69, 30.84, 31.90, 48.27, 61.13, 61.79, 124.95, 128.94, 135.61, 158.59; IR ( $\text{CHCl}_3$ ):  $\tilde{\nu}$  = 2986 (m), 2941 (m), 2867 (w), 1711 (s), 1473 (m), 1422 (s), 1386 (m), 1311 (w), 1258 (s), 1156 (m), 1117 (m), 1068 (m); HR-MS (MALDI): calcd for  $\text{C}_{11}\text{H}_{18}\text{N}_2\text{O}_3$ : 226.1317; found: 249.1208 [ $M+\text{Na}$ ]<sup>+</sup>, 227.1386 [ $M+H$ ]<sup>+</sup>.

**Compound 9d:** Obtained similarly, using Na (202 mg, 8.8 mmol, 1.05 equiv) and compound **8d** (2.98 g, 8.38 mmol, 1 equiv) and isolated as yellowish oil (1.75 g, 7.28 mmol, 87 %).  $R_f$  (hexane/acetone 1:1) = 0.27;  $^1\text{H}$  NMR (300 MHz,  $\text{CDCl}_3$ , 25 °C, TMS):  $\delta$  = 1.25–1.45 (m, 7H;  $\text{OCH}_2\text{CH}_3+2\text{CH}_2$ ), 1.52–1.60 (m, 2H;  $\text{CH}_2$ ), 1.71–1.87 (m, 3H;  $\text{CH}_2+\text{OH}$ ), 3.63 (t,  $^3J(\text{H,H})$  = 6.0 Hz, 2H;  $\text{CH}_2\text{OH}$ ), 4.37–4.47 (m, 4H;  $\text{OCH}_2\text{CH}_3+\text{NCH}_2$ ), 7.15 (s, 1H; arom. H), 7.29 (s, 1H; arom. H);  $^{13}\text{C}$  NMR (75 MHz,  $\text{CDCl}_3$ , 25 °C,  $\text{CDCl}_3$ ):  $\delta$  = 14.35, 25.31, 26.32, 31.23, 32.52, 48.42, 61.38, 62.58, 125.07, 129.29, 157.15; IR ( $\text{CHCl}_3$ ):  $\tilde{\nu}$  = 3628 (m), 3392 (m), 2986 (s), 2940 (s), 2863 (s), 1711 (s), 1510 (w), 1473 (s), 1422 (s), 1386 (s), 1360 (m), 1311 (m), 1257 (s), 1156 (s), 1117 (s), 1070 (s), 1052 (m), 1019 (m), 925  $\text{cm}^{-1}$  (m); HR-MS (MALDI): calcd for  $\text{C}_{12}\text{H}_{20}\text{N}_2\text{O}_3$ : 240.1474; found: 241.1549 [ $M+H$ ]<sup>+</sup>.

**Compounds 10a–c:** Detailed procedure for the preparation of compound **10b**:  $\text{PPh}_3$  (5.53 g, 21.1 mmol, 1 equiv) and imidazole (1.44 g, 21.1 mmol, 1 equiv) were dissolved in  $\text{CH}_2\text{Cl}_2$  and  $\text{I}_2$  (5.36 g, 21.1 mmol, 1 equiv) was added. After 10 min stirring at RT compound **9b** (4.5 g, 21.1 mmol, 1 equiv) was diluted with  $\text{CH}_2\text{Cl}_2$  and added. After 10 min stirring at RT the reaction mixture was shaken with an aqueous solution of  $\text{Na}_2\text{S}_2\text{O}_3$  and the layers

were separated. The organic phase was extracted with brine, dried with  $\text{MgSO}_4$  and the solvent was evaporated. Then the orange residue was dissolved in MeCN, compound **6** (11.7 g, 36 mmol, 1.7 equiv) and  $\text{K}_2\text{CO}_3$  (5.0 g, 36 mmol, 1.7 equiv) were added and the reaction mixture was heated to 80 °C for 22 h. After filtration the solvent was evaporated and  $\text{CH}_2\text{Cl}_2$  and an aqueous solution of  $\text{NaHCO}_3$  were added. The aqueous layer was extracted twice with  $\text{CH}_2\text{Cl}_2$ . Then the combined organic layers were extracted with brine and dried with  $\text{MgSO}_4$ . Evaporation of the solvent afforded the crude product as a brown foam (22.7 g). Purification by flash column chromatography (hexane/acetone 2:1+1%  $\text{Et}_3\text{N}$ ) afforded compound **10b** as slightly red foam (4.9 g, 9.4 mmol, 45 %).  $R_f$  (hexane/acetone 1:1) = 0.59;  $^1\text{H}$  NMR (300 MHz, DMSO, 25 °C, TMS):  $\delta$  = 0.06 (s, 9H;  $\text{SiMe}_3$ ), 1.05 (t,  $^3J(\text{H,H})$  = 8.2 Hz, 2H;  $\text{CH}_2\text{SiMe}_3$ ), 1.42 (t,  $^3J(\text{H,H})$  = 7.1 Hz, 3H;  $\text{OCH}_2\text{CH}_3$ ), 1.48 (s, 9; *t*Bu), 1.78 (m, 4H; 2  $\text{CH}_2$ ), 4.25–4.43 (m, 8H; 2  $\text{COOCH}_2+2\text{NCH}_2$ ), 6.26 (brs, 1H; NH), 6.60 (d,  $^3J(\text{H,H})$  = 2.2 Hz, 1H; arom. H), 7.06 (s, 1H; arom. H), 7.26 (s, 2H; arom. H);  $^{13}\text{C}$  NMR (75 MHz, DMSO, 25 °C, DMSO):  $\delta$  = –1.33 ( $\text{SiMe}_3$ ), 14.11 ( $\text{OCH}_2\text{CH}_3$ ), 16.94 ( $\text{CH}_2\text{SiMe}_3$ ), 27.88 ( $\text{NCH}_2\text{CH}_2\text{CH}_2\text{CH}_2\text{N}$ ), 28.18 ( $\text{C}(\text{CH}_3)_3$ ), 47.24 ( $\text{NCH}_2$ ), 47.45 ( $\text{NCH}_2$ ), 60.58 ( $\text{COOCH}_2$ ), 61.31 ( $\text{COOCH}_2$ ), 78.43 ( $\text{C}(\text{CH}_3)_3$ ), 107.56, 118.11, 123.06 (2C), 126.24, 128.64, 135.21, 152.50, 158.40, 159.99; IR ( $\text{CDCl}_3$ ):  $\tilde{\nu}$  = 3450 (w), 2983 (m), 1712 (s), 1587 (w), 1539 (w), 1472 (m), 1422 (m), 1401 (m), 1369 (m), 1253 (s), 1160 (s), 1118  $\text{cm}^{-1}$  (m); HR-MS (MALDI): calcd for  $\text{C}_{25}\text{H}_{40}\text{N}_4\text{O}_6\text{Si}$ : 520.2717; found: 543.2611 [ $M+\text{Na}$ ]<sup>+</sup>.

**Compound 10a:** Obtained similarly, using  $\text{PPh}_3$  (10.5 g, 40 mmol, 1 equiv), imidazole (2.7 g, 40 mmol, 1 equiv),  $\text{I}_2$  (10.2 g, 40 mmol, 1 equiv), compound **9a** (7.9 g, 40 mmol, 1 equiv), compound **6** (23.5 g, 72 mmol, 1.8 equiv) and  $\text{K}_2\text{CO}_3$  (10.0 g, 72 mmol, 1.8 equiv) and isolated as lightly red foam (5.1 g, 10 mmol, 25 %).  $R_f$  (hexane/acetone 1:1) = 0.40;  $^1\text{H}$  NMR (300 MHz, DMSO, 25 °C, DMSO):  $\delta$  = 0.01 (s, 9H;  $\text{SiMe}_3$ ), 0.97 (t,  $^3J(\text{H,H})$  = 8.2 Hz, 2H;  $\text{CH}_2\text{SiMe}_3$ ), 1.25 (t,  $^3J(\text{H,H})$  = 7.1 Hz, 3H;  $\text{OCH}_2\text{CH}_3$ ), 1.41 (s, 9; *t*Bu), 2.00–2.10 (m, 2H;  $\text{CH}_2$ ), 4.16–4.34 (m, 8H; 2  $\text{COOCH}_2+2\text{NCH}_2$ ), 6.62 (s, 1H; arom. H), 7.06 (s, 1H; arom. H), 7.12 (s, 1H; arom. H), 7.49 (s, 1H; arom. H), 9.14 (s, 1H; NH);  $^{13}\text{C}$  NMR (75 MHz, DMSO, 25 °C, DMSO):  $\delta$  = –0.57 ( $\text{SiMe}_3$ ), 14.88 ( $\text{OCH}_2\text{CH}_3$ ), 17.71 ( $\text{CH}_2\text{SiMe}_3$ ), 28.95 ( $\text{C}(\text{CH}_3)_3$ ), 33.35 ( $\text{NCH}_2\text{CH}_2\text{CH}_2\text{CH}_2\text{N}$ ), 46.19 ( $\text{NCH}_2$ ), 46.38 ( $\text{NCH}_2$ ), 61.32 ( $\text{COOCH}_2$ ), 62.13 ( $\text{COOCH}_2$ ), 79.22 ( $\text{C}(\text{CH}_3)_3$ ), 108.46, 118.64, 119.06, 124.04, 126.75, 129.57, 136.14, 153.25, 159.11, 160.72; IR ( $\text{CHCl}_3$ ):  $\tilde{\nu}$  = 3449 (m), 3017 (m), 2982 (m), 1711 (s), 1567 (m), 1538 (m), 1511 (w), 1470 (m), 1453 (m), 1423 (m), 1402 (m), 1369 (m), 1298 (w), 1252 (s), 1161 (s), 1117 (s), 1097 (s), 1062 (m), 861 (m), 840  $\text{cm}^{-1}$  (m); HR-MS (ESI): calcd for  $\text{C}_{24}\text{H}_{38}\text{N}_4\text{O}_6\text{Si}$ : 506.2561; found: 507.2630 [ $M+H$ ]<sup>+</sup>.

**Compound 10c:** Obtained similarly, using  $\text{PPh}_3$  (10.5 g, 40 mmol, 1 equiv), imidazole (2.7 g, 40 mmol, 1 equiv),  $\text{I}_2$  (10.15 g, 40 mmol, 1 equiv), compound **9c** (9.05 g, 40 mmol, 1 equiv), compound **6** (23.5 g, 72 mmol, 1.8 equiv) and  $\text{K}_2\text{CO}_3$  (10.0 g, 72 mmol, 1.8 equiv) and isolated as lightly red foam (5.5 g, 10.3 mmol, 26 %).  $R_f$  (hexane/acetone 1:1) = 0.55;  $^1\text{H}$  NMR (300 MHz, DMSO, 25 °C, DMSO):  $\delta$  = 0.02 (s, 9H;  $\text{SiMe}_3$ ), 0.98 (t,  $^3J(\text{H,H})$  = 8.2 Hz, 2H;  $\text{CH}_2\text{SiMe}_3$ ), 1.17 (m, 2H;  $\text{CH}_2$ ), 1.26 (t,  $^3J(\text{H,H})$  = 7.1 Hz, 3H;  $\text{OCH}_2\text{CH}_3$ ), 1.42 (s, 9; *t*Bu), 1.59–1.70 (m, 4H; 2  $\text{CH}_2$ ), 4.15–4.32 (m, 8H; 2  $\text{COOCH}_2+2\text{NCH}_2$ ), 6.59 (s, 1H; arom. H), 7.03 (s, 1H; arom. H), 7.11 (s, 1H; arom. H), 7.46 (s, 1H; arom. H), 9.10 (s, 1H; NH);  $^{13}\text{C}$  NMR (75 MHz, DMSO, 25 °C, DMSO):  $\delta$  = –0.57 ( $\text{SiMe}_3$ ), 14.88 ( $\text{OCH}_2\text{CH}_3$ ), 17.71 ( $\text{CH}_2\text{SiMe}_3$ ), 23.69 ( $\text{NCH}_2\text{CH}_2\text{CH}_2\text{CH}_2\text{N}$ ), 28.94 ( $\text{C}(\text{CH}_3)_3$ ), 31.13 ( $\text{NCH}_2\text{CH}_2\text{CH}_2\text{CH}_2\text{N}$ ), 31.44 ( $\text{NCH}_2\text{CH}_2\text{CH}_2\text{CH}_2\text{N}$ ), 48.23 ( $\text{NCH}_2$ ), 48.54 ( $\text{NCH}_2$ ), 61.31 ( $\text{COOCH}_2$ ), 62.04 ( $\text{COOCH}_2$ ), 79.18 ( $\text{C}(\text{CH}_3)_3$ ), 108.24, 118.83, 123.76, 126.92, 129.35, 135.92, 153.26, 159.18, 160.76; IR ( $\text{CHCl}_3$ ):  $\tilde{\nu}$  = 3451 (m), 3020 (m), 2982 (m), 2957 (m), 1710 (s), 1586 (m), 1539 (m), 1508 (w), 1471 (m), 1456 (m), 1422 (m), 1403 (m), 1369 (m), 1252 (s), 1236 (s), 1161 (s), 1119 (m), 1088 (m), 1062 (m), 862 (m), 840  $\text{cm}^{-1}$  (m); HR-MS (ESI): calcd for  $\text{C}_{26}\text{H}_{42}\text{N}_4\text{O}_6\text{Si}$ : 534.2874; found: 535.294 [ $M+H$ ]<sup>+</sup>.

**Compound 10d:** In a 1 L bomb compound **14** (9.36 g, 19.6 mmol, 1 equiv) was dissolved in EtOAc (100 mL) and the solution was purged with Ar. Then Pd/C (2.26 g, 10%) and  $\text{Boc}_2\text{O}$  (4.5 g, 20.6 mmol, 1.05 equiv) were added and the bomb was pressurized with  $\text{H}_2$  (35 bar). After stirring at RT for 5 h all starting material had reacted (detection by NMR of a sample of the reaction mixture since the starting material and the product are very hard to separate by TLC). Then the reaction mixture was filtered through Celite and the solvent was evaporated. Purification of the crude product by flash column chromatography (hexane/acetone 2:1+0.1%  $\text{Et}_3\text{N}$ ) afforded

compound **10d** (8.6 g, 15.7 mmol, 80%) as a colorless foam.  $R_f$  (hexane/acetone 3:2) = 0.50;  $^1\text{H NMR}$  (300 MHz, DMSO, 25 °C, DMSO):  $\delta$  = 0.01 (s, 9H; SiMe<sub>3</sub>), 0.98 (t,  $^3J(\text{H,H})$  = 7.7 Hz, 2H; CH<sub>2</sub>SiMe<sub>3</sub>), 1.20 (m, 4H; 2CH<sub>2</sub>), 1.26 (t,  $^3J(\text{H,H})$  = 7.1 Hz, 3H; OCH<sub>2</sub>CH<sub>3</sub>), 1.41 (s, 9H; *t*Bu), 1.44–1.65 (m, 4H; 2NCH<sub>2</sub>CH<sub>2</sub>), 4.14–4.31 (m, 8H; 2COOCH<sub>2</sub>+2NCH<sub>2</sub>), 6.59 (s, 1H; arom. H), 7.04 (s, 1H; arom. H), 7.10 (s, 1H; arom. H), 7.47 (s, 1H; arom. H), 9.11 (s, 1H; NH);  $^{13}\text{C NMR}$  (75 MHz, DMSO, 25 °C, DMSO):  $\delta$  = -1.32 (SiMe<sub>3</sub>), 14.16 (OCH<sub>2</sub>CH<sub>3</sub>), 16.97 (CH<sub>2</sub>SiMe<sub>3</sub>), 25.56 (2 middle CH<sub>2</sub>), 28.19 (C(CH<sub>3</sub>)<sub>3</sub>), 30.72 (NCH<sub>2</sub>CH<sub>2</sub>), 31.10 (NCH<sub>2</sub>CH<sub>2</sub>), 47.60 (NCH<sub>2</sub>), 47.91 (NCH<sub>2</sub>), 60.55 (COOCH<sub>2</sub>), 61.27 (COOCH<sub>2</sub>), 78.42 (C(CH<sub>3</sub>)<sub>3</sub>), 107.47, 118.10, 122.99, 126.18, 128.63, 135.21, 152.51, 158.46, 160.01; IR (CHCl<sub>3</sub>):  $\tilde{\nu}$  = 3450 (m), 3007 (m), 2983 (m), 2957 (m), 2863 (w), 1710 (s), 1585 (m), 1537 (m), 1511 (w), 1470 (m), 1455 (m), 1422 (m), 1404 (m), 1252 (s), 1160 (s), 1119 (m), 1102 (m), 1084 (m), 1061 (m), 997 (w), 937 (w), 861 cm<sup>-1</sup> (m); HR-MS (ESI): calcd for C<sub>27</sub>H<sub>44</sub>N<sub>4</sub>O<sub>6</sub>Si: 548.3030; found: 549.3106 [M+H]<sup>+</sup>.

**Compounds 11a–d**: Detailed procedure for the preparation of compound **11b**: Compound **10b** (4.74 g, 9.1 mmol, 1 equiv) was dissolved in THF and the solution was cooled in an ice bath. Then TBAF (27.3 mL, 1M solution in THF, 27.3 mmol, 3 equiv) was added and the reaction mixture was stirred for 14 h. Then the solvent was evaporated and CH<sub>2</sub>Cl<sub>2</sub> was added. This organic phase was extracted with aqueous citric acid (0.5M). The aqueous phase was extracted twice with CH<sub>2</sub>Cl<sub>2</sub>. Then the organic phases were combined and extracted with brine, dried with MgSO<sub>4</sub> and the solvent was evaporated, affording the tetrabutylammonium salt of the deprotected acid (5.4 g, 8.16 mmol, 90%) as a beige foam. An aliquot of this salt (1.0 g, 1.5 mmol, 1 equiv) was dissolved in DMF and HOBt (306 mg, 2.3 mmol, 1.5 equiv) and DCC (1.4 mL, 1M in CH<sub>2</sub>Cl<sub>2</sub>, 1.4 mmol, 0.95 equiv) were added. After stirring at RT for 4 h the reaction mixture was filtered and MeNH<sub>2</sub> (0.8 mL, 2M in THF, 1.6 mmol, 1.05 equiv) and DIEA (261 mL, 1.5 mmol, 1 equiv) were added. After stirring at RT for 20 min the solvent was evaporated. EtOAc and an aqueous solution of NaHCO<sub>3</sub> were added. After separation of the layers, the aqueous phase was extracted twice with EtOAc. The combined organic phases were then extracted with brine, dried with MgSO<sub>4</sub> and the solvent was evaporated. Flash column chromatography (hexane/acetone 2:3+0.1% Et<sub>3</sub>N) afforded compound **11b** (473 mg, 0.92 mmol, 61%) as colorless foam.  $R_f$  (hexane/acetone 2:3) = 0.36;  $^1\text{H NMR}$  (300 MHz, DMSO, 25 °C, DMSO):  $\delta$  = 1.26 (t,  $^3J(\text{H,H})$  = 7.1 Hz, 3H; OCH<sub>2</sub>CH<sub>3</sub>), 1.41 (s, 9H; *t*Bu), 1.57 (m, 4H; 2NCH<sub>2</sub>CH<sub>2</sub>), 2.62 (d,  $^3J(\text{H,H})$  = 4.4 Hz, 3H; CONHCH<sub>3</sub>), 4.21–4.32 (m, 6H; COOCH<sub>2</sub>+2NCH<sub>2</sub>), 6.54 (s, 1H; arom. H), 6.86 (s, 1H; arom. H), 7.03 (s, 1H; arom. H), 7.48 (s, 1H; arom. H), 7.86 (d,  $^3J(\text{H,H})$  = 4.9 Hz, 1H; CONHMe), 9.04 (s, 1H; NH (Boc));  $^{13}\text{C NMR}$  (75 MHz, DMSO, 25 °C, DMSO):  $\delta$  = 14.88 (OCH<sub>2</sub>CH<sub>3</sub>), 25.28 (COONHCH<sub>3</sub>), 26.36 (NCH<sub>2</sub>CH<sub>2</sub>), 28.99 (C(CH<sub>3</sub>)<sub>3</sub>), 29.17 (NCH<sub>2</sub>CH<sub>2</sub>), 47.78 (NCH<sub>2</sub>), 48.04 (NCH<sub>2</sub>), 61.36 (COOCH<sub>2</sub>), 78.94 (C(CH<sub>3</sub>)<sub>3</sub>), 103.99, 115.86, 122.98, 127.05, 129.39, 135.96, 153.36, 159.17, 162.11; HR-MS (MALDI): calcd for C<sub>21</sub>H<sub>31</sub>N<sub>5</sub>O<sub>5</sub>: 433.2325; found: 456.2210 [M+Na]<sup>+</sup>.

**Compound 11a**: Obtained similarly, using compound **10a** (5.0 g, 9.9 mmol, 1 equiv) and TBAF (29.6 mL, 1M in THF, 29.6 mmol, 3 equiv), affording the tetrabutylammonium salt of the deprotected acid (5.0 g, 7.7 mmol, 78%). A part of it (4.92 g, 7.59 mmol, 1 equiv) was coupled with DCC (7.21 mL, 1M in CH<sub>2</sub>Cl<sub>2</sub>), HOBt (1.54 g, 11.39 mmol, 1.5 equiv), MeNH<sub>2</sub> (4.55 mL, 2M in THF, 9.11 mmol, 1.2 equiv) and DIEA (2.64 mL, 15.18 mmol, 2 equiv), affording compound **11a** (2.30 g, 5.5 mmol, 72%) as yellowish foam.  $R_f$  (hexane/acetone 2:3) = 0.20;  $^1\text{H NMR}$  (300 MHz, DMSO, 25 °C, DMSO):  $\delta$  = 1.25 (t,  $^3J(\text{H,H})$  = 7.1 Hz, 3H; OCH<sub>2</sub>CH<sub>3</sub>), 1.41 (s, 9H; *t*Bu), 2.09 (m, 2H; NCH<sub>2</sub>CH<sub>2</sub>CH<sub>2</sub>), 2.63 (d,  $^3J(\text{H,H})$  = 3.8 Hz, 3H; CONHCH<sub>3</sub>), 4.21–4.32 (m, 6H; COOCH<sub>2</sub>+2NCH<sub>2</sub>), 6.57 (s, 1H; arom. H), 6.86 (s, 1H; arom. H), 7.06 (s, 1H; arom. H), 7.49 (s, 1H; arom. H), 7.86 (d,  $^3J(\text{H,H})$  = 4.4 Hz, 1H; CONHMe), 9.08 (s, 1H; NH (Boc));  $^{13}\text{C NMR}$  (75 MHz, DMSO, 25 °C, DMSO):  $\delta$  = 14.89 (OCH<sub>2</sub>CH<sub>3</sub>), 26.36 (COONHCH<sub>3</sub>), 28.99 (C(CH<sub>3</sub>)<sub>3</sub>), 33.65 (NCH<sub>2</sub>CH<sub>2</sub>), 46.00 (NCH<sub>2</sub>), 46.34 (NCH<sub>2</sub>), 61.35 (COOCH<sub>2</sub>), 78.97 (C(CH<sub>3</sub>)<sub>3</sub>), 104.06, 115.60, 123.15, 123.25, 126.70, 129.55, 136.14, 153.36, 159.10, 162.05; IR (CHCl<sub>3</sub>):  $\tilde{\nu}$  = 3449 (m), 2936 (m), 1710 (s), 1656 (s), 1592 (m), 1547 (w), 1462 (m), 1384 (m), 1368 (m), 1310 (w), 1156 (s), 1114 (s), 996 cm<sup>-1</sup> (w); HR-MS (ESI): calcd for C<sub>20</sub>H<sub>29</sub>N<sub>5</sub>O<sub>5</sub>: 419.2169; found: 420.2232 [M+H]<sup>+</sup>.

**Compound 11c**: Obtained similarly, using compound **10c** (5.2 g, 9.7 mmol, 1 equiv) and TBAF (29.2 mL, 1M in THF, 29.2 mmol, 3 equiv), affording the tetrabutylammonium salt of the deprotected acid (5.8 g, 8.6 mmol,

88%). A part of it (5.49 g, 8.12 mmol, 1 equiv) was coupled with DCC (7.71 mL, 1M in CH<sub>2</sub>Cl<sub>2</sub>), HOBt (1.65 g, 12.18 mmol, 1.5 equiv), MeNH<sub>2</sub> (4.87 mL, 2M in THF, 9.74 mmol, 1.2 equiv) and DIEA (2.83 mL, 16.24 mmol, 2 equiv), affording compound **11c** (3.30 g, 7.37 mmol, 91%) as yellowish foam.  $R_f$  (hexane/acetone 2:3) = 0.40;  $^1\text{H NMR}$  (300 MHz, DMSO, 25 °C, DMSO):  $\delta$  = 1.14 (m, 2H; NCH<sub>2</sub>CH<sub>2</sub>CH<sub>2</sub>), 1.26 (t,  $^3J(\text{H,H})$  = 7.1 Hz, 3H; OCH<sub>2</sub>CH<sub>3</sub>), 1.42 (s, 9H; *t*Bu), 1.56–1.69 (m, 4H; 2NCH<sub>2</sub>CH<sub>2</sub>), 2.63 (d,  $^3J(\text{H,H})$  = 4.4 Hz, 3H; CONHCH<sub>3</sub>), 4.16–4.31 (m, 6H; COOCH<sub>2</sub>+2NCH<sub>2</sub>), 6.54 (s, 1H; arom. H), 6.86 (s, 1H; arom. H), 7.04 (s, 1H; arom. H), 7.47 (s, 1H; arom. H), 7.85 (d,  $^3J(\text{H,H})$  = 4.4 Hz, 1H; CONHMe), 9.03 (s, 1H; NH (Boc));  $^{13}\text{C NMR}$  (75 MHz, DMSO, 25 °C, DMSO):  $\delta$  = 14.91 (OCH<sub>2</sub>CH<sub>3</sub>), 23.78 (NCH<sub>2</sub>CH<sub>2</sub>CH<sub>2</sub>), 26.36 (COONHCH<sub>3</sub>), 29.00 (C(CH<sub>3</sub>)<sub>3</sub>), 31.18 (NCH<sub>2</sub>CH<sub>2</sub>), 31.69 (NCH<sub>2</sub>CH<sub>2</sub>), 48.17 (NCH<sub>2</sub>), 48.28 (NCH<sub>2</sub>), 61.33 (COOCH<sub>2</sub>), 78.90 (C(CH<sub>3</sub>)<sub>3</sub>), 103.92, 115.82, 122.93, 126.97, 129.35, 135.91, 153.36, 159.19, 162.14; IR (CHCl<sub>3</sub>):  $\tilde{\nu}$  = 3451 (w), 3007 (m), 2936 (m), 1713 (s), 1656 (m), 1591 (w), 1534 (s), 1472 (m), 1422 (m), 1394 (m), 1369 (m), 1242 (s), 1161 (s), 1115 (m), 1094 (m), 1069 (m), 997 cm<sup>-1</sup> (w); HR-MS (ESI): calcd for C<sub>22</sub>H<sub>33</sub>N<sub>5</sub>O<sub>5</sub>: 447.2482; found: 448.2551 [M+H]<sup>+</sup>.

**Compound 11d**: Obtained similarly, using compound **10d** (8.6 g, 15.7 mmol, 1 equiv) and TBAF (47.1 mL, 1M in THF, 47.1 mmol, 3 equiv), affording the tetrabutylammonium salt of the deprotected acid (9.25 g, 13.4 mmol, 85%). A part of it (2.00 g, 2.9 mmol, 1 equiv) was coupled with DCC (2.75 mL, 1M in CH<sub>2</sub>Cl<sub>2</sub>, 2.75 mmol, 0.95 equiv), HOBt (588 mg, 4.35 mmol, 1.5 equiv), MeNH<sub>2</sub> (1.74 mL, 2M in THF, 3.48 mmol, 1.2 equiv) and DIEA (1 mL, 5.80 mmol, 2 equiv), affording compound **11d** (1.17 g, 2.53 mmol, 87%) as yellowish foam.  $R_f$  (hexane/acetone 2:3) = 0.50;  $^1\text{H NMR}$  (300 MHz, DMSO, 25 °C, DMSO):  $\delta$  = 1.17 (m, 4H; 2NCH<sub>2</sub>CH<sub>2</sub>CH<sub>2</sub>), 1.26 (t,  $^3J(\text{H,H})$  = 7.1 Hz, 3H; OCH<sub>2</sub>CH<sub>3</sub>), 1.40 (s, 9H; *t*Bu), 1.43–1.66 (m, 4H; 2NCH<sub>2</sub>CH<sub>2</sub>), 2.61 (d,  $^3J(\text{H,H})$  = 4.4 Hz, 3H; CONHCH<sub>3</sub>), 4.13–4.30 (m, 6H; COOCH<sub>2</sub>+2NCH<sub>2</sub>), 6.51 (s, 1H; arom. H), 6.83 (s, 1H; arom. H), 7.02 (s, 1H; arom. H), 7.46 (s, 1H; arom. H), 7.83 (d,  $^3J(\text{H,H})$  = 4.9 Hz, 1H; CONHMe), 9.02 (s, 1H; NH (Boc));  $^{13}\text{C NMR}$  (75 MHz, DMSO, 25 °C, DMSO):  $\delta$  = 14.16 (OCH<sub>2</sub>CH<sub>3</sub>), 24.51 (COONHCH<sub>3</sub>), 25.58 (2NCH<sub>2</sub>CH<sub>2</sub>CH<sub>2</sub>), 28.23 (C(CH<sub>3</sub>)<sub>3</sub>), 30.27 (NCH<sub>2</sub>CH<sub>2</sub>), 31.32 (NCH<sub>2</sub>CH<sub>2</sub>), 47.49 (NCH<sub>2</sub>), 47.61 (NCH<sub>2</sub>), 60.57 (COOCH<sub>2</sub>), 78.15 (C(CH<sub>3</sub>)<sub>3</sub>), 103.13, 114.99, 122.12, 122.30, 126.18, 128.62, 135.20, 152.04, 152.61, 158.45, 161.39; IR (CHCl<sub>3</sub>):  $\tilde{\nu}$  = 3452 (w), 3006 (m), 2938 (m), 1714 (s), 1654 (m), 1591 (m), 1534 (m), 1472 (m), 1421 (m), 1255 (m), 1160 (m), 1115 (w), 1069 cm<sup>-1</sup> (w); HR-MS (ESI): calcd for C<sub>23</sub>H<sub>35</sub>N<sub>5</sub>O<sub>5</sub>: 461.2638; found: 462.2714 [M+H]<sup>+</sup>.

**Compounds 12a–d**: Detailed procedure for the preparation of compound **12b**: Compound **11b** (764 mg, 1.76 mmol, 1 equiv) was dissolved in a solution of NaOH in MeOH/H<sub>2</sub>O 1:1 (17.6 mL, 0.1M, 1.76 mmol, 1 equiv). After shaking at 37 °C for 2 h the reaction mixture was lyophilized, affording compound **12b** as a colorless foam (712 mg, 1.67 mmol, 95%). The Na salt of the product is remarkably stable (no decomposition detectable by NMR or MS(ESI) after storage for seven months at -20 °C). However, it was always freshly prepared before the solid phase synthesis. Upon acidification the product decarboxylates spontaneously.  $^1\text{H NMR}$  (300 MHz, DMSO, 25 °C, DMSO):  $\delta$  = 1.41 (s, 9H; *t*Bu), 1.56 (m, 4H; 2NCH<sub>2</sub>CH<sub>2</sub>), 2.63 (d,  $^3J(\text{H,H})$  = 4.4 Hz, 3H; CONHCH<sub>3</sub>), 4.21 (brs, 2H; NCH<sub>2</sub>), 4.43 (brs, 2H; NCH<sub>2</sub>), 6.57 (s, 1H; arom. H), 6.73 (s, 1H; arom. H), 6.85 (s, 1H; arom. H), 7.07 (s, 1H; arom. H), 7.90 (d,  $^3J(\text{H,H})$  = 4.4 Hz, 1H; CONHMe), 9.05 (s, 1H; NH (Boc));  $^{13}\text{C NMR}$  (75 MHz, DMSO, 25 °C, DMSO):  $\delta$  = 26.36 (COONHCH<sub>3</sub>), 29.00 (C(CH<sub>3</sub>)<sub>3</sub>), 34.15 (NCH<sub>2</sub>CH<sub>2</sub>), 47.08 (NCH<sub>2</sub>), 47.97 (NCH<sub>2</sub>), 78.91 (C(CH<sub>3</sub>)<sub>3</sub>), 104.08, 115.91, 122.57, 122.98, 126.27, 145.69, 153.39, 162.14, 162.78; HR-MS (ESI): calcd for C<sub>19</sub>H<sub>27</sub>N<sub>5</sub>O<sub>5</sub>: 405.2012; found: 404.1942 [M-H]<sup>-</sup>.

**Compound 12a**: Obtained similarly, using compound **11a** (630 mg, 1.5 mmol, 1 equiv) and a solution of NaOH in MeOH/H<sub>2</sub>O 1:1 (15 mL, 0.1M, 1.5 mmol, 1 equiv) and isolated as colorless foam (615 mg, 1.49 mmol, 99%).  $^1\text{H NMR}$  (300 MHz, DMSO, 25 °C, DMSO):  $\delta$  = 1.41 (s, 9H; *t*Bu), 2.05 (m, 2H; NCH<sub>2</sub>CH<sub>2</sub>), 2.63 (d,  $^3J(\text{H,H})$  = 3.3 Hz, 3H; CONHCH<sub>3</sub>), 4.17 (t,  $^3J(\text{H,H})$  = 7.1 Hz, 2H; NCH<sub>2</sub>), 4.42 (t,  $^3J(\text{H,H})$  = 7.1 Hz, 2H; NCH<sub>2</sub>), 6.58 (s, 1H; arom. H), 6.76 (s, 1H; arom. H), 6.82 (s, 1H; arom. H), 7.06 (s, 1H; arom. H), 7.92 (d,  $^3J(\text{H,H})$  = 3.8 Hz, 1H; CONHMe), 9.07 (s, 1H; NH (Boc));  $^{13}\text{C NMR}$  (75 MHz, DMSO, 25 °C, DMSO):  $\delta$  = 26.40 (COONHCH<sub>3</sub>), 29.01 (C(CH<sub>3</sub>)<sub>3</sub>), 34.33 (NCH<sub>2</sub>CH<sub>2</sub>), 45.49 (NCH<sub>2</sub>), 46.35 (NCH<sub>2</sub>), 78.96 (C(CH<sub>3</sub>)<sub>3</sub>), 104.10, 115.51, 122.36, 123.19, 126.51, 145.78,

153.39, 162.12, 162.78; HR-MS (ESI): calcd for  $C_{18}H_{25}N_5O_5$ : 391.1856; found: 414.1735 [ $M+Na$ ]<sup>+</sup>, 392.1916 [ $M+H$ ]<sup>+</sup>.

**Compound 12c:** Obtained similarly, using compound **11c** (671 mg, 1.5 mmol, 1 equiv) and a solution of NaOH in MeOH/H<sub>2</sub>O 1:1 (15 mL, 0.1 M, 1.5 mmol, 1 equiv) and isolated as colorless foam (666 mg, 1.50 mmol, 99%). <sup>1</sup>H NMR (300 MHz, DMSO, 25 °C, DMSO): δ = 1.11 (m, 2H; CH<sub>2</sub>), 1.42 (s, 9H; *t*Bu), 1.62 (m, 4H; 2NCH<sub>2</sub>CH<sub>2</sub>), 2.63 (s, 3H; CONHCH<sub>3</sub>), 4.16 (t, <sup>3</sup>*J*(H,H) = 7.1 Hz, 2H; NCH<sub>2</sub>), 4.40 (t, <sup>3</sup>*J*(H,H) = 7.1 Hz, 2H; NCH<sub>2</sub>), 6.55 (s, 1H; arom. H), 6.73 (s, 1H; arom. H), 6.85 (s, 1H; arom. H), 7.05 (s, 1H; arom. H), 7.89 (brs, 1H; NH); <sup>13</sup>C NMR (75 MHz, DMSO, 25 °C, DMSO): δ = 23.99 (CH<sub>2</sub>), 26.38 (COONHCH<sub>3</sub>), 29.02 (C(CH<sub>3</sub>)<sub>3</sub>), 31.68 (NCH<sub>2</sub>CH<sub>2</sub>), 31.92 (NCH<sub>2</sub>CH<sub>2</sub>), 47.51 (NCH<sub>2</sub>), 48.26 (NCH<sub>2</sub>), 78.88 (C(CH<sub>3</sub>)<sub>3</sub>), 104.05, 115.87, 122.62, 123.03, 126.24, 145.59, 153.43, 162.20, 162.90; HR-MS (ESI): calcd for  $C_{20}H_{29}N_5O_5$ : 419.2169; found: 442.2051 [ $M+Na$ ]<sup>+</sup>, 420.2231 [ $M+H$ ]<sup>+</sup>.

**Compound 12d:** Obtained similarly, using compound **11d** (27 mg, 58.5 μmol, 1 equiv) and a solution of NaOH in MeOH/H<sub>2</sub>O 1:1 (585 mL, 0.1 M, 58.5 μmol, 1 equiv) (additional H<sub>2</sub>O (1 mL) and MeOH (2 mL) had to be added to completely dissolve the starting material) and isolated as yellowish foam (22 mg, 45.7 μmol, 79%). <sup>1</sup>H NMR (300 MHz, DMSO, 25 °C, DMSO): δ = 1.15 (m, 4H; 2NCH<sub>2</sub>CH<sub>2</sub>CH<sub>2</sub>), 1.42 (s, 9H; *t*Bu), 1.54–1.62 (m, 4H; 2NCH<sub>2</sub>CH<sub>2</sub>), 2.63 (d, <sup>3</sup>*J*(H,H) = 4.4 Hz, 3H; CONHCH<sub>3</sub>), 4.15 (t, <sup>3</sup>*J*(H,H) = 6.6 Hz, 2H; NCH<sub>2</sub>), 4.40 (t, <sup>3</sup>*J*(H,H) = 6.6 Hz, 2H; NCH<sub>2</sub>), 6.54 (s, 1H; arom. H), 6.72 (s, 1H; arom. H), 6.84 (s, 1H; arom. H), 7.04 (s, 1H; arom. H), 7.89 (d, <sup>3</sup>*J*(H,H) = 3.8 Hz, 1H; COONHMe), 9.04 (s, 1H; NH (Boc)); <sup>13</sup>C NMR (75 MHz, DMSO, 25 °C, DMSO): δ = 24.60 (COONHCH<sub>3</sub>), 25.63 (NCH<sub>2</sub>CH<sub>2</sub>CH<sub>2</sub>), 25.78 (NCH<sub>2</sub>CH<sub>2</sub>CH<sub>2</sub>), 28.26 (C(CH<sub>3</sub>)<sub>3</sub>), 31.25 (NCH<sub>2</sub>CH<sub>2</sub>), 31.44 (NCH<sub>2</sub>CH<sub>2</sub>), 46.76 (NCH<sub>2</sub>), 47.56 (NCH<sub>2</sub>), 78.15 (C(CH<sub>3</sub>)<sub>3</sub>), 103.24, 115.01, 121.71, 122.13, 122.38, 125.46, 145.02, 152.63, 161.46, 162.07; HR-MS (ESI): calcd for  $C_{21}H_{31}N_5O_5$ : 433.2325; found: 432.2263 [ $M-H$ ]<sup>-</sup>.

**Compound 14:** PPh<sub>3</sub> (8.73 g, 33.3 mmol, 1 equiv) and imidazole (2.27 g, 33.3 mmol, 1 equiv) were dissolved in CH<sub>2</sub>Cl<sub>2</sub> and I<sub>2</sub> (8.45 g, 33.3 mmol, 1 equiv) was added. After stirring at RT for 10 min compound **9d** (8.0 g, 33.3 mmol, 1 equiv) was diluted with CH<sub>2</sub>Cl<sub>2</sub> and added. After stirring at RT for 10 min the reaction mixture was shaken with an aqueous solution of Na<sub>2</sub>S<sub>2</sub>O<sub>3</sub> and the phases were separated. The aqueous layer was extracted three times with CH<sub>2</sub>Cl<sub>2</sub>. The combined organic layers were extracted with brine, dried with MgSO<sub>4</sub> and the solvent was evaporated. The resulting orange residue (20 g) was dissolved in MeCN and compound **5** (10.0 g, 40 mmol, 1.2 equiv) and K<sub>2</sub>CO<sub>3</sub> (11.5 g, 83.2 mmol, 2.5 equiv) were added. This mixture was heated to 80 °C with vigorous stirring for 3 h. After filtration the solvent was evaporated and CH<sub>2</sub>Cl<sub>2</sub> and aqueous NaHCO<sub>3</sub> were added. After separation of the layers the aqueous phase was extracted twice with CH<sub>2</sub>Cl<sub>2</sub>. The combined organic phases were extracted with brine, dried with MgSO<sub>4</sub> and the solvent was evaporated. The residue was subjected to flash column chromatography (hexane/acetone 2:1+1% Et<sub>3</sub>N), affording compound **14** as a yellow liquid (10.55 g, 22 mmol, 66%). *R*<sub>f</sub> (hexane/acetone 3:2) = 0.50; <sup>1</sup>H (300 MHz, CDCl<sub>3</sub>, 25 °C, TMS): δ = 0.05 (s, 9H; SiMe<sub>3</sub>), 0.98 (t, <sup>3</sup>*J*(H,H) = 8.2 Hz, 2H; CH<sub>2</sub>SiMe<sub>3</sub>), 1.33 (m, 4H; 2CH<sub>2</sub>), 1.40 (t, <sup>3</sup>*J*(H,H) = 7.1 Hz, 3H; OCH<sub>2</sub>CH<sub>3</sub>), 1.77 (m, 4H; 2CH<sub>2</sub>), 4.29–4.41 (m, 8H; 2COOCH<sub>2</sub>+2NCH<sub>2</sub>), 7.04 (s, 1H; arom. H), 7.12 (s, 1H; arom. H), 7.37 (d, <sup>3</sup>*J*(H,H) = 2.2 Hz, 1H; arom. H), 7.59 (d, <sup>3</sup>*J*(H,H) = 2.2 Hz, 1H; arom. H); <sup>13</sup>C NMR (75 MHz, CDCl<sub>3</sub>, 25 °C, CDCl<sub>3</sub>): δ = -1.42 (SiMe<sub>3</sub>), 14.31 (OCH<sub>2</sub>CH<sub>3</sub>), 17.39 (CH<sub>2</sub>SiMe<sub>3</sub>), 25.97 (2 middle CH<sub>2</sub>), 30.93 (NCH<sub>2</sub>CH<sub>2</sub>), 30.98 (NCH<sub>2</sub>CH<sub>2</sub>), 48.26 (NCH<sub>2</sub>), 50.22 (NCH<sub>2</sub>), 61.35 (COOCH<sub>2</sub>), 63.26 (COOCH<sub>2</sub>), 112.74, 122.40, 125.00, 126.45, 129.34, 135.13, 157.13, 158.89, 159.91; IR (CHCl<sub>3</sub>):  $\tilde{\nu}$  = 3143 (m), 2985 (s), 2958 (s), 2863 (s), 1711 (s), 1540 (s), 1511 (s), 1473 (s), 1422 (s), 1385 (s), 1371 (s), 1318 (s), 1252 (s), 1151 (s), 1107 (s), 1082 (s), 925 cm<sup>-1</sup> (m); HR-MS (ESI): calcd for  $C_{22}H_{34}N_4O_6Si$ : 478.2248; found: 479.2324 [ $M+H$ ]<sup>+</sup>.

**Compound 15:** Obtained analogously to compound **11d**, using compound **10d** (8.6 g, 15.7 mmol, 1 equiv) and TBAF (47.1 mL, 1 M in THF, 47.1 mmol, 3 equiv), affording the tetrabutylammonium salt of the deprotected acid (9.25 g, 13.4 mmol, 85%). A part of it (2.00 g, 2.9 mmol, 1 equiv) was coupled with DCC (2.75 mL, 1 M in CH<sub>2</sub>Cl<sub>2</sub>, 2.75 mmol, 0.95 equiv), HOBt (588 mg, 4.35 mmol, 1.5 equiv), NH<sub>3</sub> (7.0 mL, 0.5 M in dioxane, 3.48 mmol, 1.2 equiv) and DIEA (1 mL, 5.80 mmol, 2 equiv), affording compound **15** (1.2 g, 2.68 mmol, 92%) as colorless foam. *R*<sub>f</sub> (hexane/acetone 2:3) = 0.38; <sup>1</sup>H NMR (300 MHz, DMSO, 25 °C, DMSO): δ = 1.16 (m, 4H; 2NCH<sub>2</sub>CH<sub>2</sub>CH<sub>2</sub>), 1.25 (t, <sup>3</sup>*J*(H,H) = 7.1 Hz, 3H; OCH<sub>2</sub>CH<sub>3</sub>), 1.40 (s, 9H;

*t*Bu), 1.43–1.66 (m, 4H; 2NCH<sub>2</sub>CH<sub>2</sub>), 4.14–4.30 (m, 6H; COOCH<sub>2</sub>+2NCH<sub>2</sub>), 6.58 (s, 1H; arom. H), 6.70 (brs, 1H; CONH<sub>2</sub>), 6.84 (s, 1H; arom. H), 7.02 (s, 1H; arom. H), 7.38 (brs, 1H; CONH<sub>2</sub>), 7.46 (s, 1H; arom. H), 8.99 (s, 1H; NH (Boc)); <sup>13</sup>C NMR (75 MHz, DMSO, 25 °C, DMSO): δ = 14.17 (OCH<sub>2</sub>CH<sub>3</sub>), 25.54 (2 NCH<sub>2</sub>CH<sub>2</sub>CH<sub>2</sub>), 28.24 (C(CH<sub>3</sub>)<sub>3</sub>), 30.71 (NCH<sub>2</sub>CH<sub>2</sub>), 31.26 (NCH<sub>2</sub>CH<sub>2</sub>), 47.52 (NCH<sub>2</sub>), 47.61 (NCH<sub>2</sub>), 60.58 (COOCH<sub>2</sub>), 78.13 (C(CH<sub>3</sub>)<sub>3</sub>), 104.40, 115.67, 121.90, 122.00, 128.64, 135.20, 152.67, 158.45, 162.71; IR (CHCl<sub>3</sub>):  $\tilde{\nu}$  = 3534 (w), 3449 (w), 3417 (w), 2984 (m), 2938 (m), 2862 (m), 1713 (s), 1665 (s), 1599 (w), 1575 (m), 1536 (w), 1510 (w), 1467 (w), 1423 (w), 1323 (w), 1255 (m), 1160 (s), 1121 (w), 1070 (w), 998 cm<sup>-1</sup> (w); HR-MS (ESI): calcd for  $C_{22}H_{33}N_5O_5$ : 447.2482; found: 448.2558 [ $M+H$ ]<sup>+</sup>.

**Compound 16:** Obtained analogously to compound **12d**, using compound **15** (31 mg, 69.3 μmol, 1 equiv) and a solution of NaOH in MeOH/H<sub>2</sub>O 1:1 (693 mL, 0.1 M, 69.3 μmol, 1 equiv) (additional MeOH (1.5 mL) had to be added to completely dissolve the starting material) and isolated as yellowish foam (23 mg, 49.6 μmol, 72%). <sup>1</sup>H NMR (300 MHz, DMSO, 25 °C, DMSO): δ = 1.15 (m, 4H; 2NCH<sub>2</sub>CH<sub>2</sub>CH<sub>2</sub>), 1.41 (s, 9H; *t*Bu), 1.54–1.62 (m, 4H; 2NCH<sub>2</sub>CH<sub>2</sub>), 4.16 (t, <sup>3</sup>*J*(H,H) = 6.6 Hz, 2H; NCH<sub>2</sub>), 4.40 (t, <sup>3</sup>*J*(H,H) = 7.1 Hz, 2H; NCH<sub>2</sub>), 6.60 (s, 1H; arom. H), 6.72 (s, 1H; arom. H), 6.84 (s, 1H; arom. H), 7.05 (s, 1H; arom. H); <sup>13</sup>C NMR (75 MHz, DMSO, 25 °C, DMSO): δ = 25.75 (NCH<sub>2</sub>CH<sub>2</sub>CH<sub>2</sub>), 28.28 (C(CH<sub>3</sub>)<sub>3</sub>), 31.20 (NCH<sub>2</sub>CH<sub>2</sub>), 31.39 (NCH<sub>2</sub>CH<sub>2</sub>), 46.77 (NCH<sub>2</sub>), 47.57 (NCH<sub>2</sub>), 78.00 (C(CH<sub>3</sub>)<sub>3</sub>), 104.53, 115.77, 121.87, 122.32, 125.49, 144.94, 152.83, 162.82; HR-MS (ESI): calcd for  $C_{20}H_{29}N_5O_5$ : 419.2169; found: 442.2057 [ $M+Na$ ]<sup>+</sup>.

**Compound 17:** PPh<sub>3</sub> (5.25 g, 20 mmol, 1 equiv) and imidazole (1.36 g, 20 mmol, 1 equiv) were dissolved in CH<sub>2</sub>Cl<sub>2</sub> and I<sub>2</sub> (5.08 g, 20 mmol, 1 equiv) was added. After stirring at RT for 10 min compound **9d** (4.81 g, 20 mmol, 1 equiv) was dissolved in CH<sub>2</sub>Cl<sub>2</sub> and added. After stirring at RT for 10 min the reaction mixture was shaken with an aqueous solution of Na<sub>2</sub>S<sub>2</sub>O<sub>3</sub> and the layers were separated. The aqueous layer was extracted three times with CH<sub>2</sub>Cl<sub>2</sub>. Then the combined organic layers were extracted with brine, dried with MgSO<sub>4</sub> and the solvent was evaporated. The orange residue (14.5 g) was purified by flash column chromatography (hexane/acetone 2:1) to afford compound **17** (5.25 g, 15 mmol, 75%) as yellow oil. *R*<sub>f</sub> (hexane/acetone 2:1) = 0.45; <sup>1</sup>H (300 MHz, CDCl<sub>3</sub>, 25 °C, TMS): δ = 1.34–1.46 (m, 7H; 2CH<sub>2</sub>+OCH<sub>2</sub>CH<sub>3</sub>), 1.77–1.84 (m, 4H; ICH<sub>2</sub>CH<sub>2</sub>+NCH<sub>2</sub>CH<sub>2</sub>), 3.17 (t, <sup>3</sup>*J*(H,H) = 7.1 Hz, 2H; CH<sub>2</sub>I), 4.37–4.44 (m, 4H; 2COOCH<sub>2</sub>+NCH<sub>2</sub>), 7.11 (s, 1H; arom. H), 7.15 (s, 1H; arom. H); <sup>13</sup>C NMR (75 MHz, CDCl<sub>3</sub>, 25 °C, CDCl<sub>3</sub>): δ = 6.61 (CH<sub>2</sub>I), 14.03 (OCH<sub>2</sub>CH<sub>3</sub>), 25.10 (NCH<sub>2</sub>CH<sub>2</sub>CH<sub>2</sub>), 29.58 (ICH<sub>2</sub>CH<sub>2</sub>CH<sub>2</sub>), 30.68 (NCH<sub>2</sub>CH<sub>2</sub>), 32.84 (ICH<sub>2</sub>CH<sub>2</sub>), 47.96 (NCH<sub>2</sub>), 60.94 (COOCH<sub>2</sub>), 124.75 (C5 of imidazole), 128.93 (C4 of imidazole), 135.51 (C2 of imidazole), 158.48 (CO); IR (CHCl<sub>3</sub>):  $\tilde{\nu}$  = 2986 (s), 2939 (s), 2861 (m), 1710 (s), 1511 (w), 1473 (s), 1422 (s), 1386 (s), 1304 (m), 1257 (s), 1141 (s), 1108 (s), 1071 (m), 1011 cm<sup>-1</sup> (w); HR-MS (ESI): calcd for  $C_{12}H_{29}N_2O_2I$ : 350.0491; found: 351.0568 [ $M+H$ ]<sup>+</sup>.

**Compound 18:** Compound **17** (3.47 g, 9.9 mmol, 1.1 equiv) was dissolved in MeCN (50 mL). Then 3-nitropyrrrole<sup>[13]</sup> (1.01 g, 9.0 mmol, 1.0 equiv) and K<sub>2</sub>CO<sub>3</sub> (2.5 g, 18.0 mmol, 2.0 equiv) were added and the reaction mixture was heated to 80 °C for 12 h. After filtration the solvent was evaporated. CH<sub>2</sub>Cl<sub>2</sub> and an aqueous solution of NaHCO<sub>3</sub> were added. After separation of the layers the aqueous layer was extracted twice with CH<sub>2</sub>Cl<sub>2</sub>. The combined organic phases were extracted with brine, dried with MgSO<sub>4</sub> and the solvent was evaporated. The crude product was purified by flash column chromatography (hexane/acetone 2:1+0.1% Et<sub>3</sub>N), affording compound **18** (2.03 g, 6.07 mmol, 67%) as a yellowish oil. *R*<sub>f</sub> (ethyl acetate) = 0.40; <sup>1</sup>H (300 MHz, CDCl<sub>3</sub>, 25 °C, TMS): δ = 1.33–1.46 (m, 7H; 2CH<sub>2</sub>+OCH<sub>2</sub>CH<sub>3</sub>), 1.79–1.82 (m, 4H; 2NCH<sub>2</sub>CH<sub>2</sub>), 3.88 (t, <sup>3</sup>*J*(H,H) = 7.1 Hz, 2H; N(Py)CH<sub>2</sub>), 4.40 (m, 4H; 2COOCH<sub>2</sub>+N(Im)CH<sub>2</sub>), 6.54 (t, <sup>3</sup>*J*(H,H) = 2.7 Hz, 1H; H4 of Py), 6.70 (dd, <sup>3</sup>*J*(H,H) = 1.8, 2.7 Hz, 1H; H5 of Py), 7.06 (d, <sup>3</sup>*J*(H,H) = 0.9 Hz, 1H; H5 of Im), 7.15 (d, <sup>3</sup>*J*(H,H) = 1.2 Hz, 1H; H4 of Im), 7.50 (t, <sup>3</sup>*J*(H,H) = 2.1 Hz, 1H; H2 of Py); <sup>13</sup>C NMR (75 MHz, CDCl<sub>3</sub>, 25 °C, CDCl<sub>3</sub>): δ = 14.32 (OCH<sub>2</sub>CH<sub>3</sub>), 25.95 (NCH<sub>2</sub>CH<sub>2</sub>CH<sub>2</sub>), 30.64 (NCH<sub>2</sub>CH<sub>2</sub>), 30.95 (NCH<sub>2</sub>CH<sub>2</sub>), 48.20 (N(Im)CH<sub>2</sub>), 50.63 (N(Py)CH<sub>2</sub>), 61.38 (COOCH<sub>2</sub>), 105.52 (C5 of Py), 121.14 (C2 or C4 of Py), 121.35 (C4 or C2 of Py), 125.00 (C5 of Im), 129.38 (C4 of Im), 135.87 (C3 of Py or C2 of Im), 136.58 (C2 of Im or C3 of Py), 158.90 (CO); IR (CDCl<sub>3</sub>):  $\tilde{\nu}$  = 2943 (m), 2863 (w), 1710 (s), 1532 (m), 1514 (m), 1489 (s), 1473 (m), 1422 (s), 1385 (m), 1365 (m), 1294 (s), 1257 (m), 1155 (m), 1129 (m),

1072 cm<sup>-1</sup> (m); HR-MS (ESI): calcd for C<sub>16</sub>H<sub>22</sub>N<sub>4</sub>O<sub>4</sub>: 334.1641; found: 335.1716 [M+H]<sup>+</sup>.

**Compound 19:** Compound **18** (0.9 g, 2.7 mmol, 1 equiv) was dissolved in EtOAc and Boc<sub>2</sub>O (617 mg, 2.83 mmol, 1.05 equiv) was added. After purging the solution with Ar, Pd/C (311 mg, 10%) was added. This mixture was stirred under a H<sub>2</sub> atmosphere (35 bar) at RT for 3.5 h. Then it was filtered and the solvent was evaporated. Purification by flash column chromatography (hexane/acetone 2:1+0.1% Et<sub>3</sub>N) afforded compound **19** as a colorless oil (0.96 g, 2.37 mmol, 88%). R<sub>f</sub> (hexane/acetone 1:1) = 0.56; <sup>1</sup>H (300 MHz, CDCl<sub>3</sub>, 25 °C, TMS): δ = 1.30 (m, 4H; 2CH<sub>2</sub>), 1.43 (t, <sup>3</sup>J(H,H) = 7.1 Hz, 3H; OCH<sub>2</sub>CH<sub>3</sub>), 1.49 (s, 9H; *t*Bu), 1.70–1.80 (m, 4H; 2NCH<sub>2</sub>CH<sub>2</sub>), 3.76 (t, <sup>3</sup>J(H,H) = 7.1 Hz, 2H; N(Py)CH<sub>2</sub>), 4.34–4.44 (m, 4H; 2COOCH<sub>2</sub>+N(Im)CH<sub>2</sub>), 5.85 (t, <sup>3</sup>J(H,H) = 2.2 Hz, 1H; C<sub>4</sub> of Py), 6.24 (brs, 1H; NH), 6.43 (t, <sup>3</sup>J(H,H) = 2.7 Hz, 1H; C<sub>5</sub> of Py), 6.87 (brs, 1H; C<sub>2</sub> of Py), 7.04 (s, 1H; C<sub>5</sub> of Im), 7.14 (s, 1H; C<sub>4</sub> of Im); <sup>13</sup>C NMR (75 MHz, CDCl<sub>3</sub>, 25 °C, CDCl<sub>3</sub>): δ = 14.37 (OCH<sub>2</sub>CH<sub>3</sub>), 26.14 (NCH<sub>2</sub>CH<sub>2</sub>CH<sub>2</sub>), 26.26 (NCH<sub>2</sub>CH<sub>2</sub>CH<sub>2</sub>), 28.46 (C(CH<sub>3</sub>)<sub>3</sub>), 31.10 (2NCH<sub>2</sub>CH<sub>2</sub>), 48.38 (N(Im)CH<sub>2</sub>), 49.78 (N(Py)CH<sub>2</sub>), 61.36 (COOCH<sub>2</sub>), 79.56 (C(CH<sub>3</sub>)<sub>3</sub>), 99.86 (C<sub>4</sub> of Py), 109.91 (C<sub>2</sub> or C<sub>5</sub> of Py), 118.52 (C<sub>5</sub> or C<sub>2</sub> of Py), 122.58 (C<sub>3</sub> of Py), 125.08 (C<sub>5</sub> of Im), 129.35 (C<sub>4</sub> of Im), 135.93 (C<sub>2</sub> of Im), 157.10 (CO (Boc)), 158.93 (COOEt); IR (CHCl<sub>3</sub>):  $\tilde{\nu}$  = 2956 (m), 2863 (w), 1712 (s), 1577 (w), 1540 (m), 1491 (m), 1422 (m), 1390 (m), 1369 (m), 1312 (w), 1250 (s), 1165 (s), 1120 (m), 1072 (w), 1059 (w), 1019 cm<sup>-1</sup> (w); HR-MS (ESI): calcd for C<sub>21</sub>H<sub>32</sub>N<sub>4</sub>O<sub>4</sub>: 404.2424; found: 405.2499 [M+H]<sup>+</sup>.

**Compound 20:** Compound **19** (291 mg, 0.72 mmol, 1 equiv) was dissolved in a solution of NaOH in MeOH/H<sub>2</sub>O 1:1 (3.6 mL, 0.2M, 0.72 mmol, 1 equiv). After shaking at 37 °C for 12 h the reaction mixture was lyophilized, affording compound **20** as a yellowish foam (280 mg, 0.70 mmol, 98%). This compound was always freshly prepared before the solid-phase synthesis. <sup>1</sup>H NMR (300 MHz, DMSO, 25 °C, DMSO): δ = 1.18 (m, 4H; 2CH<sub>2</sub>), 1.41 (s, 9H; *t*Bu), 1.59–1.64 (m, 4H; 2NCH<sub>2</sub>CH<sub>2</sub>), 3.70 (t, <sup>3</sup>J(H,H) = 7.1 Hz; 2H, NCH<sub>2</sub>), 4.42 (t, <sup>3</sup>J(H,H) = 7.1 Hz; 2H; NCH<sub>2</sub>), 5.79 (s, 1H; arom. H), 6.46 (s, 1H; arom. H), 6.70 (s, 1H; arom. H), 6.74 (s, 1H; arom. H), 7.06 (s, 1H; arom. H); <sup>13</sup>C NMR (75 MHz, DMSO, 25 °C, DMSO): δ = 25.68 (NCH<sub>2</sub>CH<sub>2</sub>CH<sub>2</sub>), 25.79 (NCH<sub>2</sub>CH<sub>2</sub>CH<sub>2</sub>), 28.37 (C(CH<sub>3</sub>)<sub>3</sub>), 30.93 (NCH<sub>2</sub>CH<sub>2</sub>), 31.16 (NCH<sub>2</sub>CH<sub>2</sub>), 46.76 (NCH<sub>2</sub>), 48.72 (NCH<sub>2</sub>), 77.22 (C(CH<sub>3</sub>)<sub>3</sub>), 99.86, 108.77, 118.01, 121.78, 124.48, 125.47, 144.93, 152.99, 162.09; HR-MS (ESI): calcd for C<sub>19</sub>H<sub>28</sub>N<sub>4</sub>O<sub>4</sub>: 376.2111; found: 399.2011 [M+Na]<sup>+</sup>.

**Construction of plasmid DNA:** To obtain the plasmid pAH2, the oligonucleotide strands printed in bold face in Figure 6 were hybridized and then ligated (Roche rapid ligation kit) into linearized pUC19<sup>[17]</sup> (*Bam*HI/*Hind*III) using T4 DNA ligase. The resultant construct was used to transform JM109 cells (Promega). Ampicillin-resistant white colonies were selected from Luria-Bertani medium-agar plates containing ampicillin (50 mg mL<sup>-1</sup>), IPTG (120 mg mL<sup>-1</sup>) and XGAL (40 mg mL<sup>-1</sup>) and grown in Luria-Bertani medium. Then the plasmid was isolated using the Qiagen HiSpeed Plasmid Purification Kit. The sequence was verified by dideoxy sequencing using the primers PBD1f (5'-CTGCGCAACTGTTGGGAAGGG-3') and PBD1r (5'-GGGCAGT-GAGCGCAACGCAAT-3'). The plasmid pDEH9 had been prepared in a similar way by S. E. Swalley and D. E. Herman.

**Preparation of 3'-end-labeled restriction fragments:** Following a literature procedure,<sup>[20]</sup> the plasmids pDEH9 and pAH2 were linearized with *Eco*RI and *Pvu*II and then treated with Klenow enzyme, deoxyadenosine 5'-[<sup>32</sup>P]triphosphate and thymidine 5'-[<sup>32</sup>P]triphosphate. After separation on a non-denaturing polyacrylamide gel the desired band was visualized by autoradiography and isolated. Chemical sequencing reactions were performed according to published methods.<sup>[21]</sup>

## Acknowledgement

We are grateful to the National Institutes of Health for research support, to the Alexander von Humboldt-Foundation (Germany) for a Feodor Lynen Fellowship for A.H. and to Dr. Bogdan Olenyuk for helpful discussions.

[1] a) P. B. Dervan, *Bioorg. Med. Chem.* **2001**, *9*, 2215–2235; b) P. B. Dervan, R. W. Bürlü, *Curr. Opin. Chem. Biol.* **1999**, *3*, 688–693; c) S.

- Janssen, T. Durussel, U. K. Laemmli, *Mol. Cell* **2000**, *6*, 999–1011; d) K. Maeshima, S. Janssen, U. K. Laemmli, *EMBO J.* **2001**, *20*, 3218–3228; e) M. P. Gygi, M. D. Ferguson, H. C. Mefford, P. L. Kevin, C. O'Day, P. Zhou, C. Friedman, G. van den Engh, M. L. Stobowitz, B. J. Trask, *Nucleic Acids Res.* **2002**, *30*, 2790–2799.
- [2] V. C. Rucker, S. Foister, C. M. Melander, P. B. Dervan, *J. Am. Chem. Soc.* **2003**, *125*, 1195–1202.
- [3] An obvious limitation of this model is that pairing of a dip (as in A·T) with another dip (as in Py/Im, this is the second situation from the top in the mismatch column in Figure 1) is mechanically possible in this model. However, for the sake of simplicity, we did not want to resort to more difficult recognition surfaces but chose to phrase the rules accordingly. However, after a slight modification of the rules, the model can easily be extended to also illustrate the so-called 1:1 binding mode (cf. A. R. Urbach, P. B. Dervan, *Proc. Natl. Acad. Sci. USA* **2001**, *98*, 4343–4348).
- [4] In a mixture of two different unconnected polyamide strands (with for example four residues each) with DNA two 1:1 complexes and three 2:1 complexes can potentially be formed. In 2:1 complexes the polyamides either bind as a homodimer (if two molecules of the same strand bind side by side) or a heterodimer.
- [5] a) M. Mrksich, M. E. Parks, P. B. Dervan, *J. Am. Chem. Soc.* **1994**, *116*, 7983–7988; b) M. Mrksich, P. B. Dervan, *J. Am. Chem. Soc.* **1993**, *115*, 9892–9899.
- [6] S. E. Swalley, E. E. Baird, P. B. Dervan, *J. Am. Chem. Soc.* **1999**, *121*, 1113–1120.
- [7] J. M. Belitsky, D. H. Nguyen, N. R. Wurtz, P. B. Dervan, *Bioorg. Med. Chem.* **2002**, *10*, 2767–2774.
- [8] See for example: a) G. Burckhardt, H. Simon, E. Birch-Hirschfeld, L. Kittler, S. K. Sharma, J. W. Lown, C. Zimmer, *J. Biomol. Struct. Dyn.* **2002**, *19*, 1101–1109; b) C. C. O'Hare, D. Mack, M. Tandon, S. K. Sharma, J. W. Lown, M. L. Kopka, R. E. Dickerson, J. A. Hartley, *Proc. Natl. Acad. Sci. USA* **2002**, *99*, 72–77; c) W. A. Greenberg, E. E. Baird, P. B. Dervan, *Chem. Eur. J.* **1998**, *4*, 796–805; d) Y. H. Chen, Y. W. Yang, J. W. Lown, *J. Biomol. Struct. Dyn.* **1996**, *14*, 341–355; e) Y. H. Chen, J. W. Lown, *Biophys. J.* **1995**, *68*, 2041–2048; f) Y. H. Chen, J. W. Lown, *J. Am. Chem. Soc.* **1994**, *116*, 6995–7005; g) M. Mrksich, P. B. Dervan, *J. Am. Chem. Soc.* **1994**, *116*, 3663–3664; h) M. Mrksich, P. B. Dervan, *J. Am. Chem. Soc.* **1993**, *115*, 9892–9899.
- [9] B. Olenyuk, C. Jitianu, P. B. Dervan, *J. Am. Chem. Soc.* **2003**, *125*, 4741–4745.
- [10] C. Melander, V. Rucker, P. B. Dervan, unpublished results.
- [11] a) For solid-phase synthesis using the Boc strategy see: E. E. Baird, P. B. Dervan, *J. Am. Chem. Soc.* **1996**, *118*, 6141–6146; b) for Fmoc strategy see: N. R. Wurtz, J. M. Turner, E. E. Baird, P. B. Dervan, *Org. Lett.* **2001**, *3*, 1201–1203; c) for a solid-phase synthesis strategy of polyamides with a variety of different tail residues see ref. [7].
- [12] T. Nishiguchi, K. Kawamine, T. Ohtsuka, *J. Org. Chem.* **1992**, *57*, 312–316.
- [13] B. L. Bray, P. H. Mathies, R. Naef, D. R. Solas, T. T. Tidwell, D. R. Artis, J. M. Muchowski, *J. Org. Chem.* **1990**, *55*, 6317–6328.
- [14] Iodide **17** is a remarkably stable compound which can for example be heated under the conditions of the alkylation (also in the presence of OPPh<sub>3</sub>) without the nucleophile for several days without any signs of decomposition.
- [15] For the synthesis of compounds **21** and **22** see ref. [11a]. Compound **24** was obtained according to ref. [2]. Compound **25** can be obtained according to ref. [16].
- [16] W. S. Wade, M. Mrksich, P. B. Dervan, *J. Am. Chem. Soc.* **1992**, *114*, 8783–8794.
- [17] C. Yanisch-Perron, J. Vieira, J. Messing, *Gene* **1985**, *33*, 103–119.
- [18] For examples see ref. [8b] and S. White, E. E. Baird, P. B. Dervan, *Chem. Biol.* **1997**, *4*, 569–578; M. E. Parks, E. E. Baird, P. B. Dervan, *J. Am. Chem. Soc.* **1996**, *118*, 6153–6159.
- [19] H. E. Gottlieb, V. Kotlyar, A. Nudelman, *J. Org. Chem.* **1997**, *62*, 7512–7515.
- [20] J. W. Trauger, P. B. Dervan, *Methods Enzymol.* **2001**, *340*, 450–466.
- [21] a) B. L. Iverson, P. B. Dervan, *Nucleic Acids Res.* **1987**, *15*, 7823–7830; b) A. M. Maxam, W. S. Gilbert, *Methods Enzymol.* **1980**, *65*, 499–560.

Received: January 29, 2003 [F4784]